

2021 Edition

BAREFOOT WATER-SKI TECHNICAL RULES — 2021



This book belongs to:

Copyright 2021 by International Waterski & Wakeboard Federation (IWWF) - World Barefoot Council. All Rights Reserved.

Reproduction of any part or whole of this document is prohibited unless written permission has been obtained from the IWWF World Barefoot Council.

Date: January 19, 2021

THE GREATEST BAREFOOT AMBASSADOR OF THEM ALL!



BANANA GEORGE BLAIR

Thirty-six years ago, George first sponsored the printing of the International Waterski and Wakeboard Federation's World Barefoot Council Technical Rule Book. George supported and inspired the World Barefoot Council to ensure that our skiers and officials have the tools and rules they need to keep the Barefoot playing field level for everyone.

The World of Barefooting continues to honor the legacy that George has left and will forever be thankful to "Banana" for embracing our sport with such infectious enthusiasm!

TABLE OF CONTENTS

PART I: TOURNAMENT REQUIREMENTS

CHAPTER 1: ABBREVIATIONS AND DEFINITIONS

101: Abbreviations	2
102: Definitions	2

CHAPTER 2: GENERAL REQUIREMENTS

201: Introduction	4
202: Convention	4
203: Exceptions to the Rules	4
204: Interpretation of the Rules	4
205: Rules Revision	4
206: Amendments to the Rules	4
207: Rule Change Procedure	4
208: New Tricks	5
209: Interruptions and Stoppage	5
210: Disqualification	5
211: Results Posting	5
212: Replacing Officials	6
213: Event Judges	6
214: WBC Ranking List	6
215: Adaptive Performance	6

CHAPTER 3: SKIER INSTRUCTIONS

301: Commands	7
302: Jump Event	7
303: Slalom and Trick Event	7

CHAPTER 4: JUMP EVENT

401: Start	9
402: Start of Pass—Jump Attempt	9
403: Passes—Jumps	9
404: Credit for Registered Jumps	9
405: Disallowed Jump and Registered Fall	9
406: Scoring	9
407: Jump Measurement and Calculation	9
408: Distance	10
409: Officials	10

CHAPTER 5: SLALOM EVENT

501: Passes	11
502: Start of Recording	12
503: End of Pass	12
504: Credit	12
505: Scoring	13
506: Officials	14

CHAPTER 6: START TRICKS

601: General	15
602: Scoring	15
603: Dock, Tower, or Land Start (Flyer)	15
604: Start Trick Descriptions	16

CHAPTER 7: PASS TRICKS—GENERAL REQUIREMENTS

701: Passes	18
702: Start of Time and Recording	18
703: End of Scoring	18
704: Credit for Tricks	18
705: Skier Responsibility	18
706: Loss of BSP	18
707: Repeating Failed Tricks	19
708: Trick After Expiration of Time	19
709: Reverse Tricks	19
710: Simultaneous Tricks	19
711: Precursory Tricks	19
712: Scoring—Trick Point Values	20
713: Bonus Actions	20
714: Officials	20
715: Downgrades	21
716: One Attempt for Credit	21

CHAPTER 8: PASS TRICK DESCRIPTION

801: General Pass Tricks	22
802: Turn Tricks General	24
803: Rotation Rules for Turn Tricks	25
804: 180 Back-to-Front	25
805: 180 Front-to-Back	25

806: 360 Front-to-Front	26
807: 360 Back-to-Back	26
808: 540 Turns	26
809: 720 Turns	27
810: Step-Over Turns	27
811: Rope-on-Foot Turn Feet-to-Feet	28
812: Rope-on-Foot Turn Toe-Start Recovery	28
813: Somersault	28
CHAPTER 9: PROTESTS	29
901: Protest Basis	29
902: Protest Procedure	29
903: Chief Judge Decision	29
904: Reverse Chief Judge Decision	29
905: Calculation Error	29
CHAPTER 10: RE-RIDES	31
1001: Re-Ride Request	31
1002: Scoring of Re-Ride	31
1003: Optional Re-Ride	31
1004: Mandatory Re-Ride	31
1005: Re-Rides—When Taken	32
1006: Re-Ride Options—Trick	32
1007: Not Basis for a Re-Ride	32
1008: Start and Pass Instructions	33
1009: Refusal to Enter Course	33
1010: Provisional Score	33
CHAPTER 11: SAFETY	34
1101: Safety Director	34
1102: Flotation and Protection	34
1103: Helmets	34
1104: Safety Officer	34
1105: Disqualification	35
CHAPTER 12: TIMING RULES	36
1201: Turnaround Times	36
1203: Emergency, One-Minute	36
1204: Injury Recovery, Up to Three-Minutes	36
1205: Re-Ride, Five-Minute Rest	36
1206: Temporary Incapacitation	36

CHAPTER 13: VIDEO AND RADIOS	37
1301: Assignment	37
1302: Media	37
1303: Official Use	37
1304: Communications	37

PART II: HOMOLOGATION REQUIREMENTS

CHAPTER 14: HANDLES, ROPES, TIMERS, AND JUMP RAMP	47
1401: General	47
1402: Handles	47
1403: Ropes	47
1404: Skier Supplied Rope and Handle	48
1405: Audible Timing Device	48
1406: Jump Ramp	48
CHAPTER 15: TOWBOATS	50
1501: Towboat Specifications	50
1502: Top Speed	50
1503: Speed Check	50
1504: Speed Control	50
CHAPTER 16: COURSE REQUIREMENTS	51
1601: Jump Course	51
1602: Slalom and Trick Course	51
CHAPTER 17: WORLD RECORDS	53
1701: Recognition	53
1702: Tournament	53
1703: Jump	53
1704: Slalom and Tricks	53
1705: Equal Performance	53
1706: Affidavit—Claim Documentation	53
1707: Verification	54
1708: Record Appeals	54
1709: Ratification	54
1710: Records Set at World Championship	54

PART III: WORLD CHAMPIONSHIPS REQUIREMENTS

CHAPTER 18: GENERAL REQUIREMENTS WORLD CHAMPIONSHIP

1801: Scheduling.....	58
1802: Site Closure and Set Up.....	58
1803: On-Site Medical Facilities	58
1804: Towboats.....	58
1805: Ropes and Handles.....	58
1806: Safety Director.....	58
1807: Driver Familiarization	59
1808: Completion	59
1809: Validity	59

CHAPTER 19: DIVISIONS, EVENTS, AND ROUNDS OF COMPETITION—WORLD CHAMPIONSHIP

1901: Divisions of Competition.....	60
1902: Events.....	60
1903: Champion and Event Placements.....	60
1904: Number of Event Rounds	60
1905: Schedule of Events.....	60
1906: Site Familiarization	61
1907: Seeding Scores.....	61
1908: Starting Order.....	61
1909: Jr/Sr Division Second/Final Round	62
1910: Open Division Second Round	62
1911: Open Division Third/Final Round.....	62
1912: Last Qualifier Tie Breaking.....	62

CHAPTER 20: ENTRY REQUIREMENTS—WORLD CHAMPIONSHIP

2001: Nationality	63
2002: Team Composition.....	63
2003: Independent Entrants.....	63
2004: Jump Proficiency.....	64
2005: Entry Registration.....	64

CHAPTER 21: OVERALL AND TEAM RANKING—WORLD CHAMPIONSHIP

2101: Event Placing	66
2102: Champions	66

2103: Ties.....	66
2104: Overall Scoring—Application	67
2105: Overall Scoring—Calculation	67
2106: Qualification for Overalls	67
2107: Overall Placing	67
2108: Team Placing	67
2109: Score Sheets Access	68

CHAPTER 22: OFFICIALS—WORLD CHAMPIONSHIP

2201: Chief Officials.....	69
2202: Appointed Judges, Scorers and Drivers.....	69
2203: Secondary Positions.....	69
2204: Independence	70
2205: Replacing Officials.....	70
2206: Affidavit.....	70

CHAPTER 23: VIDEO—WORLD CHAMPIONSHIP

2301: Appointments.....	71
2302: Availability.....	71
2303: Boat Loading	71

PART IV: RULE CLARIFICATIONS

CHAPTER 24: EXPLANATORY NOTES

Rule 208: New Tricks	73
Rule 213(B): Minimum Requirements For Boat Officials.....	73
Rule 214: Wbc Ranking List	73
Rule 407: Jump Measurement and Calculation.....	73
Rule 712: Credit for Pass Tricks	73
Rule 903: Chief Judge Decision.....	74
Rule 1303: Official Use	74
Rule 1303(A)(2): Failure of Timing Device	75
Rule 1303(A)(3): Exceptional Circumstances.....	75
Rule 1501: Boat Specifications	75
Rule 1706: Affidavit—Claim Documentation.....	76
Rule 1906: Site Familiarization	76
Rule 2204: Independence	77

Part I:

TOURNAMENT REQUIREMENTS

CHAPTER 1: Abbreviations and Definitions	2
CHAPTER 2: General Requirements	4
CHAPTER 3: Skier Instructions	7
CHAPTER 4: Jump Event	9
CHAPTER 5: Slalom Event.....	11
CHAPTER 6: Start Tricks	15
CHAPTER 7: Pass Tricks—General Requirements	18
CHAPTER 8: Pass Trick Description	22
CHAPTER 9: Protests.....	29
CHAPTER 10: Re-Rides.....	31
CHAPTER 11: Safety	34
CHAPTER 12: Timing Rules.....	35
CHAPTER 13: Video and Radios.....	37
PART I: Graphics	38

CHAPTER 1: ABBREVIATIONS AND DEFINITIONS

101: ABBREVIATIONS

BSP: Barefoot Skiing Position

LOC: Local Organizing Committee

RC: Record Capable

RL: World Ranking List

RRC: Records Review Committee

WBC: World Barefoot Council,
www.WorldBarefootCouncil.com

102: DEFINITIONS

Appointed Officials. Chief Judge, Chief Scorer, Chief Driver, Chief Video Operator, Homologator, Assistant Chief Judge, Assistant Chief Scorer, Event Judges, Scorers, Drivers, Safety Director, and Tournament Director.

Barefoot Skiing Position.

(A) Barefoot Skiing Position (BSP). Barefoot Skiing Position shall be instantly recognized upon the skier satisfying all of the following conditions:

- (1) Handle.** The skier has possession of the handle.
- (2) Stable Position.** The skier is riding on the water on one or two bare feet in a stable position and the handle is held in a position that allows the skier's position to be held at will. A stationary position is not required.
- (3) Foot/Feet.** The weight of the skier is entirely supported by the foot or feet on the water.

(B) Neutral BSP. The skier is on two-feet, forward or backward, with both hands gripping the handle.

(C) Line BSP. The skier is backward with the handle held only between the legs while gripping the handle with one or two hands.

(D) One-Foot BSP.

- (1) For the Trick Event, the entire lifted foot shall be at least halfway between the skiers' other knee and the water surface.

- (2) For the Slalom Event, the skiers lifted foot shall be seen to be clear of the water surface.

(E) Rope-on-Foot BSP. The skier shall have both hands free from the handle and the surface of the water and only the lifted foot holds the handle. The rope shall be in line with the center of the skier's body.

(F) Slide-Slide BSP. Both feet are held in a position at least 90 degrees to the path of the towboat.

Communicator Judge. Nominated Event Judge for communication between the skier and boat officials for the event.

Event Judges. Judges assigned to adjudicate the event as per rule 213.

Equalization Pass. Equalization passes are taken with the approval of the Chief Judge whenever the boat crew has exceeded the turnaround time by a margin that allows conditions to become substantially different to the other competitors in the event.

Fall. Any time after the skier signifies his readiness to commence and any one of the following occurs:

- (A) The skier loses possession of the handle.
- (B) The weight of the skier is not primarily supported by his foot/feet (except where a skier is supported by other parts of the body as prescribed in the official description of a specific trick or after negotiating the jump) and the skier is unable to regain BSP before the end of the pass.

Force Majeure. Circumstances beyond the control of all parties, e.g. acts of God such as severe weather.

Leveling Pass. Leveling passes are taken before every event. During this pass the boat crew distribute themselves to produce the optimum wake. Top speed, 15 second timer, and all speed measuring devices should also be checked during this pass.

Local Organizing Committee (LOC). The LOC is the committee that organizes the tournament.

Multiple Turn. Any surface, line, wake or wake-to-wake turn greater than 180 degrees.

PPG. Policies Procedures, and Guidelines is the document that contains additional information regarding technical rule interpretations/clarifications, skier rankings, codes of conduct and instructions for completing the Homologation dossier, as may be referenced in the Technical Rules.

Plant. When a skier's foot/feet is/are on the water and takes his weight in preparation to attain BSP.

Rankings List (RL). Ranking List of skiers from around the world and their placement with all other competitors.

Record Capability (RC). Record Capability tournaments are the only recognized events where World Records can be set.

Record Review Committee (RRC). The Record Review Committee is the committee that reviews the World Barefoot Records and adjudicates the outcome.

Speed.

(A) Use of Speed Tolerance. The Driver must attempt to drive to the exact requested speed and never intentionally use the speed tolerance.

(B) Course Speed. The skiers requested speed through the course, +/- the tolerance for the event.

(C) Start Speed. The skiers requested speed for the start portion of the pass, +/- the tolerance for the event.

(D) Planing Speed/RPM. The skier's requested speed/RPM for planing during the second phase of acceleration up to start or course speed, +/- the tolerance for this phase. 303D

(E) Speed Greater Than 72 kph/44.7 mph. Failure to attain speeds greater than 72 kpm/44.7 mph shall not be grounds for a re-ride [1007(E)].

Wake. The area of water disturbed by the passage of the towboat lying at rope's length between and including the Wake Crests (lift-off points).

Wake Crest (lift-off point). The Wake Crest (lift-off point) is the nominal boundary of the wake and shall be the lift-off points for both slalom and tricks. For towboats that create extra waves within the wake, the crest of the outermost waves shall be considered the Wake Crest (lift-off point).

(A) Smooth Shoulder. If the wake wave has a smooth rounded shoulder, the wave crest (lift-off point) is the point where the wave shoulder begins the downturn to the outside of the wake.

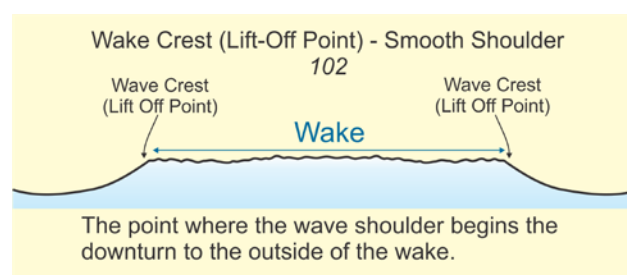

(B) Curled Shoulder. If the wake wave has a curled shoulder, the wave curl is the point of the wave crest (lift-off point).

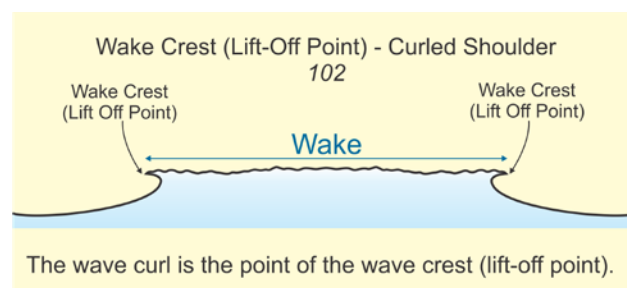

CHAPTER 2: GENERAL REQUIREMENTS

201: INTRODUCTION

These rules become effective on the January 1, 2021 and shall govern all World Barefoot Waterski Championships, WBC Record Capability tournaments, and WBC Ranking List Tournaments thereafter until superseded.

These rules have been drafted in English. In case of conflicting interpretation, only the English text shall be considered authentic.

202: CONVENTION

The use of a singular pronoun shall also include the plural and vice versa.

203: EXCEPTIONS TO THE RULES

Where compliance with the rules is not feasible, the Chief Judge shall, with the approval of a majority of the Appointed Officials, make the necessary change, inform each skier by posting, and send a report to the WBC. Where the rules are definite and feasible, a vote of the Appointed Officials to decide whether to enforce any provision is prohibited.

204: INTERPRETATION OF THE RULES

(A) WBC Interpretations. Questions of interpretation of the rules shall be referred to the WBC when possible. All interpretations approved by the WBC shall be published on the official WBC web site www.WorldBarefootCouncil.com and are final.

(B) Chief Judge. If an interpretation from the WBC is not possible and an interpretation is not contained in the PPG, the Chief Judge shall make an interpretation and the Chief Judge shall make a report to the WBC concerning the question.

205: RULES REVISION

It is the policy of the WBC to review the rules annually and publish the revised rules (if any) on 1 January of each calendar year. The WBC shall also review the rules at all meetings of the Council. The new rules shall become effective when the WBC publishes them on the official WBC website.

206: AMENDMENTS TO THE RULES

(A) Extraordinary Circumstances. In extraordinary circumstances, the WBC is permitted to amend the rulebook at any time. Rule amendments made prior to the next January 1st publication of the rulebook shall be approved by a minimum of seven voting members of the WBC and are effective immediately upon publication on the official WBC web site.

(B) Federation Technical Rules. For WBC RC or RL tournaments, no federation may adopt technical rules that conflict with these WBC technical rules. Wherever such conflicts exist, those conflicting federation technical rule(s) shall not apply or the scores shall not be valid for submission to WBC.

(C) Exceptions to the Rules. In appropriate circumstances, the Council may create exceptions to these Rules, whenever necessary. Such exceptions are effective upon notification via an announcement on the WBC web site.

207: RULE CHANGE PROCEDURE

(A) How to Submit. Any person may submit a proposal to add, edit or delete a requirement of the Technical Rules, via any member of the WBC Rules Committee.

(B) Proposal Content. The proposal shall contain the following:

- (1) Identify the rule number to be revised where applicable.
- (2) The text requested to be added, deleted, or revised.
- (3) The reason for the rule change.

(C) Contact Us. E-mail to the WBC Rules Committee. The address can be found online at www.WorldBarefootCouncil.com.

(D) Approval. The WBC Rules Committee shall review the proposed change and following approval by the WBC Rules Committee shall be sent to the WBC for consideration.

208: NEW TRICKS

To qualify new tricks for inclusion in the next World Championships, applications for those new tricks shall be submitted to any member of the WBC no less than 120 days before the next World Championships and the WBC shall then adjudicate on them no less than 60 days before the next World Championships. This application shall be in the form of a video recording of the perfect trick on the long line accompanied by a written description of the trick, and proposed point value for consideration by the WBC.

209: INTERRUPTIONS AND STOPPAGE

- (A) **Interruptions.** In the case of an interruption of the tournament, the tournament shall be restarted as soon as possible without delay.
- (B) **Stoppage.** In the case of a stoppage, the tournament restart shall be announced 10 minutes ahead of time.

210: DISQUALIFICATION

- (A) **Safety Compliance.** Failure of a skier to wear a wet suit, proper protection and flotation under a dry suit or helmet when required shall be cause of immediate disqualification from that round of the event by the Safety Director.
- (B) **Danger to Himself.** No skier shall be allowed to compete or continue to compete if, in the opinion of the Chief Judge, Safety Director and a majority of the Event Judges, his competing would be a danger to himself or to other skiers in the tournament. Whenever practical the advice of a doctor shall be obtained.
- (C) **Unsportsmanlike Conduct.** A skier may be disqualified by a majority vote of the Appointed Officials due to actions of the skier, parent, spouse or representative who may be charged with unsportsmanlike conduct because of extended or unwarranted harassment of an official or other competitor on behalf of the skier.
- (D) **Detrimental to the Sport.** A skier may be disqualified by a majority vote of the Appointed Officials due to actions considered detrimental to the LOC or actions considered detrimental to the sport of barefoot water skiing.

- (E) **Not Ready at Starting Dock.** Once the starting order is posted, it is the responsibility of the skier to be present at the starting dock in time for his turn. Any skier who fails to be on immediate hand and in condition to ski when the towboat is ready for him shall be disqualified from that round of the event.
- (F) **Does Not Respond after 10-Second Call.** The skier shall indicate his readiness to go after the 10-second call by the Event Judges. Where a skier fails to indicate his readiness to go by the expiry of the 10 seconds, the Communicator Judge shall call "TIME" and raise his hand to indicate the expiration of time. Should the skier not immediately signal the towboat with either the "STOP" or "IN GEAR," followed immediately by "OK" the Communicator Judge shall advise the skier that he has been disqualified for that pass.
- (G) **Emergency Minute.** The disqualification of a skier [1203 or 210] shall be treated as an emergency for the next skier and the skier shall be granted one emergency minute to prepare to ski. An additional emergency minute shall be granted for each skier in turn that is disqualified.

211: RESULTS POSTING

- (A) **As Soon As Possible.** Event results, electronic, paper or both shall be officially posted as soon as reasonably possible after the conclusion of the daily events. If the results are not available 30 minutes after the last skier of the day, the official posting will be delayed (except after the last final) until 30 minutes after the start of the next day's competition proceedings.
- (B) **Time of Posting.** The Chief Judge shall record the official time of posting on the event result sheet (electronic or paper copy).

212: REPLACING OFFICIALS

The Chief Judge is permitted to replace Event Judges and Drivers during an event at his discretion. Such changeovers shall take place between groups.

213: EVENT JUDGES

- (A) **Jump Event**

(1) WBC World Ranking List (RL) Tournament. The minimum qualifications shall be:

- (a) Boat Judge— Level 3
- (b) Video Judge 1— Level 3
- (c) Video Judge 2— Level 4

(2) WBC Record Capability (RC) Tournament. The minimum qualifications shall be:

- (a) Boat Judge— Level 3
- (b) Video Judge 1— Level 2
- (c) Video Judge 2— Level 3

(3) World Barefoot Championships. The minimum qualifications shall be:

- (a) Boat Judge— Level 1
- (b) Video Judge 1— Level 1
- (c) Video Judge 2— Level 1

(B) Slalom and Trick Event.**(1) WBC World Ranking List (RL) Tournament.** The minimum qualifications of the Event Judges shall be two Level 3 Judges and one Level 4 Judge. Combinations of other level judges are allowed; however, there shall never be more than one level 4 Judge in the towboat. For single Judge events, a single Level 1 or Level 2 Judge shall be in the towboat.**(2) WBC Record Capability (RC) Tournament.** The minimum qualifications of the Event Judges shall be one Level 2 Judge, one Level 3 Judge, and one Level 4 Judge. Combinations of other level judges are allowed; however, there shall never be less than one Level 2 Judge and never more than one Level 4 Judge in the towboat. For single Judge events, a single Level 1 or Level 2 Judge shall be in the towboat.**(3) World Barefoot Championships.** There shall be three Level 1 Judges in the towboat. A single Level 1 Judge is permitted to replace the three Judges in the towboat in order to attain and maintain a minimum of 72 kph/44.7mph through the course as required in 1501(A).**214: WBC RANKING LIST**

(A) Published List. The WBC shall publish ranking list scores for jump distance, slalom crossings, and tricks points for all divisions as set forth in the PPG. The Confederations are permitted to recognize ranking lists for divisions other than those recognized by the WBC but those rankings shall have no influence on the WBC World Ranking List.

(B) Where Set. Ranking scores shall be set only at tournaments homologated by the WBC, a Confederation, or an Affiliated Federation.

(C) Rounds.

- (1) No more than four rounds per day are permitted in any one competition.
- (2) Ranking list rounds shall be declared before the start of the competition.

215: ADAPTIVE PERFORMANCE

Should any skier with a physical impairment desire adaptation of these rules to allow the said skier to participate in a competition/s conducted in accordance with the IWWF Barefoot Technical Rules, the said skier or their appointed representative should seek adaption to the relevant rules in writing, sent to the Chair of IWWF WBC and cc to the Chair of the IWWF WBC—Rules Committee. The requested adaptation to the rules is to provide as much detail as possible in respect to what adaptations are being requested, including, reference to existing rules where applicable and how such adaptation to the rules will foster full participation by the impaired skier.

The WBC Rules Committee will consider the request and make a recommendation to the WBC.

The WBC Rules Committee is also empowered to make a recommendation's as to the inclusion of adaptive performance rules in the IWWF Barefoot Technical Rules for any impaired skier, as circumstances may require from time to time.

CHAPTER 3: SKIER INSTRUCTIONS

301: COMMANDS

(A) **Terminology.** When preparing to start from rest, the skier shall communicate with the towboat only with the words “IN GEAR,” “OK,” or “STOP.” The towboat shall only proceed on the “OK” command [1007(B)].

For safety purposes and to ensure proper communication with the towboat, the “STOP” command can be communicated to the towboat crew by raising one hand, thus visually as well as verbally communicating the command to the towboat crew.

(B) **Start of Pass.** A skier is considered to have started the pass once the skier gives the “OK” command to the towboat crew.

302: JUMP EVENT

The skier’s instructions to the Communicator Judge prior to starting a pass shall consist of:

(A) **Point of Attachment.** The skier shall specify the point of rope attachment: “low,” “middle,” or “high.” It is the skier’s responsibility to ensure that the rope is attached at the proper height.

(B) **Rates of Acceleration.** The requested rates of acceleration in the terms “slow,” “medium,” or “fast” for the corresponding three phases: pull out of the water, ride over the bumps, and acceleration to speed.

(C) **Path.** The towboat shall follow a straight path, parallel to and on the left side of the ramp surface in accordance with the skier’s instructions as follows:

(1) **Wide.** The towboat shall pass as close to the outside buoys as feasible but shall not go over the buoy.

(2) **Split.** The towboat shall pass halfway between the two buoys.

(3) **Close.** The towboat shall pass as close to the inside buoys as feasible but shall not go over the buoy.

(D) **Speed.**

(1) **Requested Course Speed.** The speed through the jump course shall be requested by the skier in units of 1 kph/½mph or the maximum speed of 72 kph/44.7 mph.

(A) **Speed Attained.** That course speed shall be attained not later than when the towboat reaches the jump course entry gates.

(B) **Speed Notification.** On achieving course speed, the driver shall notify the towboat Judge(s) by calling “speed.”

(C) **Course Speed Tolerance.** +/- 1.5kph /1mph.

303: SLALOM AND TRICK EVENT

The skier’s instructions to the Communicator Judge prior to starting a pass shall consist of:

(A) **Point of Attachment.** The skier shall tell the Event Judges the height of rope attachment: “low,” “middle,” or “high.” It is the skier’s responsibility to ensure that the rope has been attached at the proper height.

(B) **Start Trick and Declaration of Additional Equipment.** The start trick listed in 604 that the skier proposes to perform **and whether the skier intends to use any additional equipment for the second trick pass.**

(C) **Rates of Acceleration.** The requested rates of acceleration using only the terms “slow,” “medium” or “fast,” for the three phases: pull out of the water or off the dock, tower, or dry land; ride over the bumps; and acceleration to speed.

(1) At the skier’s discretion, the second phase may be enlarged with other instructions such as, but not limited to; a planing speed/rpm, out of the wash, plant, or spin around.

(D) **Planing Speed.**

(1) The planing speed/rpm shall be given in units of 1 kph/½mph/100 rpm.

- (2) Once the planing rpm or speed is achieved it shall be held according to the skier's instructions.
- (3) Immediately following the planing portion of the start, the speed shall be adjusted to the start or course speed.

(E) Requested Speeds.

- (1) The skier is permitted to request differing start and course speeds. The start and course speeds shall be given in units of 1 kph/½mph.
 - (a) **Start Speed.** Once start speed has been attained it shall be held according to the skier's instructions.
 - (b) **Course Speed.** Once the course speed has been attained it shall be held constant until the skier loses possession of the handle or the boat reaches the shutdown buoy.
- (2) **Speed Notification.** On achieving planing, start and course speed, the driver shall notify the towboat Judge(s) by calling "speed."
- (3) **Speed Tolerance.**
 - (a) **Start and Course Speed Tolerance.**
+/-1kph/½mph
 - (b) **Planing Speed/RPM Tolerance.**
+/-5kph/3mph/200 rpm.

(F) Declared First Trick.

- (1) The skier has the option to declare the BSP the skier intends to enter the course in as well as the first trick. Time shall start at the first movement towards that trick, even if the skier does not complete the trick.

- (2) In the case where the skier declares the skier will enter the course backward but falls prior to the course and recovers to a forward BSP time shall start at the first movement toward any trick after the tumble turn recovery.
- (3) If the skier does not declare a BSP or first trick then time shall start at the first movement toward any pass trick listed in Chapter 8.

(G) Speed Signal for Skier.

The skier may request a signal when the planing, start, and/or course speed is attained.

- (1) **Signal.** This signal can take the form of sound, a hand signal, a tap/chop on the rope, or other available form of signal recognized by the skier as permitted by the Chief Judge.
- (2) **When Signal Not Required.** The requested signal is not required if the skier attempts the start or commences the pass before the start and/or course speed is reached.

(H) Engine Trim Position.

The skier can request the driver to change the engine trim position from the default position and is responsible to approve its placement before commencing.

(I) Slalom Handle.

The 38cm tournament supplied handle shall be the default handle for the slalom event. If they desire, the skier may request a 30cm handle before the start of the pass. [1007(N)].

CHAPTER 4: JUMP EVENT

401: START

The skier shall start by means of a deep-water start and shall pass the start-of-course buoy in forward BSP and maintain it to the ramp, both to be judged from the towboat.

402: START OF PASS—JUMP ATTEMPT

A skier is considered to have started the pass once the skier gives the “OK” command to the Boat Judges in accordance with 301(B).

403: PASSES—JUMPS

- (A) **Number of Jumps.** In each round each skier shall be allowed three registered jumps.
- (B) **Exceptional Circumstances.** In exceptional circumstances the Chief Judge and the Appointed Officials are authorized to vote to reduce the number of jumps for a round to a minimum of two and post a notification before the start of the round affected.
- (C) **Skier Loses Helmet.** If a skier loses his helmet during the start or before reaching the jump ramp, the towboat shall immediately stop unless it's unsafe to do so. Should it be unsafe for the towboat to stop, the skier shall ski past the jump whenever possible, and this jump shall be registered as a Fall. These are not grounds for disqualification from the remainder of the event.

404: CREDIT FOR REGISTERED JUMPS

- (A) **Jump Scored.** All jump attempts not annulled by a re-ride shall be registered jumps.
- (B) **BSP after Jump.** After landing a jump, the skier can release the handle at any time after attaining BSP.
- (C) **End of Course.** Once the Event Judge has recognized BSP after a landed jump, he may request the Driver to start slowing the towboat.
- (D) **Departure Point.** After each jump the skier shall be dropped into the water and ride back to the departure point in the towboat.

405: DISALLOWED JUMP AND REGISTERED FALL

- (A) **Disallowed Jump.** A jump shall be disallowed if the towboat speed through the jump course is judged to have exceeded 73.5 kph/45.7 mph as checked by a GPS speed-measuring device while the skier is in possession of the handle and prior to BSP being recognized after the jump.
- (B) **Registered Fall.** A jump shall be registered as a Fall if:
 - (1) **BSP Prior to Ramp.** The skier does not attain BSP by the start-of-course gate buoys and/or fails to maintain BSP through the course to the ramp.
 - (2) **BSP after Ramp.** The skier does not attain BSP before the end-of-course buoy.
 - (3) **Contact with Ramp.** Any part of the skier other than the feet contact the ramp
 - (4) **Loss of Helmet.** Skier loses their helmet before reaching the jump ramp.
 - (5) The Chief Judge shall be called upon to adjudicate if the Event Judges are unable to make an immediate ruling.

406: SCORING

The skier's longest registered jump distance in a round shall be declared the skier's score for that round.

407: JUMP MEASUREMENT AND CALCULATION

A WBC approved video jump-measurement program shall be used to obtain jump distances and shall produce results that are reproducible on readily available systems, and the distance gleaned from the video will be final. See the PPG for approved jump measurement systems.

See Part IV: Explanatory Notes.

408: DISTANCE

- (A) **Points of Measurement.** Jump distances shall be measured from a point on the surface of the water perpendicularly below the center of the top edge of the ramp, to the point of contact closest to the ramp.
- (B) **Measurement Increments.** Jump distances shall be scored in increments of one-tenth meter.
- (C) **Skier Not Making Landing Box.** In the case of a successful jump that is unreadable due to the skier not making it to the landing box, the distance awarded will be the lowest distance readable on the screen, minus one-tenth meter.
- (D) **Skier Exceeding Landing Box.** In the case of a successful jump that is unreadable due to the skier jumping past the landing box, the distance that will be awarded will be the longest readable distance on the screen, plus one-tenth meter.
- (E) **Malfunction.** Should a malfunction of the jump measuring equipment render an otherwise valid jump to be unreadable, the skier shall be offered an optional re-ride [1003(G)] or the lowest distance readable on the screen, minus one-tenth meter.

409: OFFICIALS

- (A) **Judges.**
 - (1) **Boat Judge.** One Event Judge shall ride in the towboat to observe towboat path, course speed, the skier's performance in relation to maintaining BSP from start-of-course buoy, over the ramp, and regaining BSP after the landing before the end-of-course buoy, and Driver's compliance with the skier's instructions.
 - (2) **Video Judges.** There shall be two Event Judges stationed at the video monitor who shall agree on the positioning of the cursor. If necessary, the Event Judges shall use the video replay facility to determine the landing point. If the two Event Judges fail to agree, a third Appointed Judge shall be called in and he will position the cursor himself. The median value among the three distance readouts shall be taken as the official jump distance.
 - (3) **Agreement.** By observing the speed measuring devices, the Driver and Boat Judge shall agree that the skier received their requested speed through the course.
- (B) **Speed Adjudicator.** Where a speed control system is not used, a Speed Adjudicator shall ride in the towboat to verify the boat speed via GPS. In the event of a disagreement between the Driver and Boat Judge, the speed recorded on the Speed Adjudicator's GPS shall be used.
- (C) **Safety Swimmer.** A safety swimmer wearing a life vest and trained in water rescue and a floating stretcher/backboard shall be located adjacent to the jump ramp during the jump event.

CHAPTER 5: SLALOM EVENT

501: PASSES

The skier shall attain BSP by any start trick listed in 604 and the skier may reverse direction before starting the pass.

(A) Two 15-Second Passes. In each round, each skier shall be allowed two 15-second passes through the slalom course, during which the skier can earn points

(B) Passes in the Same Direction. If all or any portion of two passes are made in the same direction (forward or backward) then the points for the lower-scoring pass or portion of the pass shall be calculated at 25 percent of the scored value rounded to two decimal places (.01).

(C) Combination Backward/Forward Pass. If during a backward pass a skier, for whatever reason, changes to the forward position, the skier can recommence crossing forward and receive credit for those forward crossings as set out in 501(B).

Table 501(B). Forward Slalom Pass Value after 25% Multiplier Applied

Score	Applied	Score	Applied	Score	Applied	Score	Applied
0.1	0.03	2.1	0.53	4.1	1.03	6.1	1.53
0.2	0.05	2.2	0.55	4.2	1.05	6.2	1.55
0.3	0.08	2.3	0.58	4.3	1.08	6.3	1.58
0.4	0.10	2.4	0.60	4.4	1.10	6.4	1.60
0.5	0.13	2.5	0.63	4.5	1.13	6.5	1.63
0.6	0.15	2.6	0.65	4.6	1.15	6.6	1.65
0.7	0.18	2.7	0.68	4.7	1.18	6.7	1.68
0.8	0.20	2.8	0.70	4.8	1.20	6.8	1.70
0.9	0.23	2.9	0.73	4.9	1.23	6.9	1.73
1.0	0.25	3.0	0.75	5.0	1.25	7.0	1.75
1.1	0.28	3.1	0.78	5.1	1.28	7.1	1.78
1.2	0.30	3.2	0.80	5.2	1.30	7.2	1.80
1.3	0.33	3.3	0.83	5.3	1.33	7.3	1.83
1.4	0.35	3.4	0.85	5.4	1.35	7.4	1.85
1.5	0.38	3.5	0.88	5.5	1.38	7.5	1.88
1.6	0.40	3.6	0.90	5.6	1.40	7.6	1.90
1.7	0.43	3.7	0.93	5.7	1.43	7.7	1.93
1.8	0.45	3.8	0.95	5.8	1.45	7.8	1.95
1.9	0.48	3.9	0.98	5.9	1.48	7.9	1.98
2.0	0.50	4.0	1.00	6.0	1.50	8.0	2.00

502: START OF RECORDING

(A) **First Movement.** The Boat Judge(s) shall start the audible timing device and recording at the skier's first movement toward the wake from BSP outside the wake.

(1) **Away from Wake.** If the skier skis away from the wake before starting to cross (i.e. to attack the wake or gain momentum), this will not be held to be a first movement toward the wake, and the pass will not start until the skier turns **and moves** back toward the wake.

(2) **Drifting into Wake.** Drifting into the curl of the wake following the start is not to be considered a first movement toward the wake

(B) **Testing Speed.** Positioning tricks or testing the speed with a one-foot need not be declared.

503: END OF PASS

(A) **Shutdown Buoy.** If the towboat passes the shutdown buoy before the 15 seconds have elapsed, the Driver shall smoothly close the throttle and maintain a safe path until the towboat stops. The skier may continue executing crossings while the towboat is slowing down and the Event Judges will continue to record them, noting when the timing device sounds the end of the 15 seconds.

504: CREDIT

(A) **Skier Responsibility.** It is responsibility of the skier to show the Event Judge(s) that he has fully crossed the wake in BSP.

(B) **Two-Foot Crossing.**

(1) **Full.** A perfect two-foot crossing is credited when the skier has crossed the entire wake in Two-Foot BSP.

(2) **Partial.** The skier will receive credit for a partial two-foot when the:

- (a) Crossing in progress is interrupted by the expiry of time.
- (b) In the case of a skier losing the handle during a crossing, the skier shall receive credit for a two-foot crossing up to the point of losing BSP.

(C) **One-Foot Crossing.**

(1) **Full.** A perfect one-foot crossing shall be credited when the skier has crossed the entire wake with the lifted foot/leg completely clear of the water before the lift-off point of the first wake wave and remaining clear until the skiing foot has completely passed the lift-off point of the second wake wave.

(2) **Partial.** A partial one-foot crossing shall only be credited if it is part of a perfect one-foot crossing during which the 15-second period expires.

(D) **Points Scored.** Points shall be awarded for full and partial crossings made during the pass as follows:

(1) **Two-Foot Crossings.**

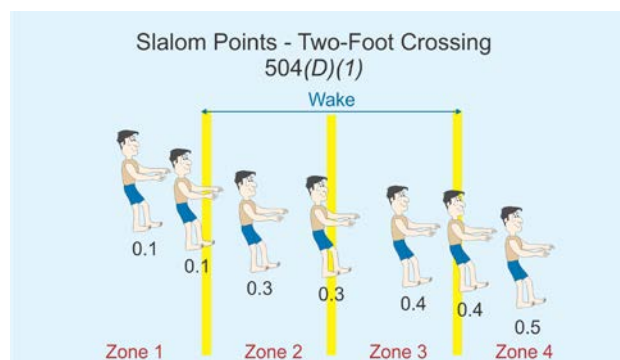

(a) A full two-foot crossing shall be scored as 0.5 points (Zone 4).

(b) A partial two-foot crossing shall be scored as follows:

(1) 0.1 points if the skier is in movement toward the wake, but not yet having past the lift-off point of the first wake wave with both feet (Zone 1).

(2) 0.3 points if the skier has passed the lift-off point of the first wake wave but has not passed the center of the wake with both feet (Zone 2).

(3) 0.4 points if the skier has passed the center of the wake but has not passed the lift-off point of the second wake wave with both feet (Zone 3).

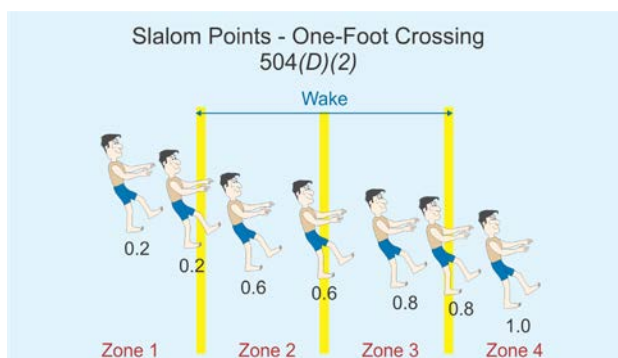
(2) One-Foot Crossings.

(a) A perfect one-foot crossing shall be scored as 1.0 points (Zone 4).

(b) A partial one-foot crossing shall be scored as follows:

(1) 0.2 points if the skier is in movement toward the wake, but not yet having past the lift-off point of the first wake wave with the supporting foot (Zone 1).

(2) 0.6 points if the skier has passed the lift-off point of the first wake wave but has not passed the center of the wake with the supporting foot (Zone 2).

(3) 0.8 points if the skier has passed the center of the wake but has not passed the lift-off point of the second wake wave with the supporting foot (Zone 3).

(c) An imperfect one-foot crossing shall be scored as a two-foot crossing.

(E) Scoring Zero. The crossing in which the skier is engaged shall score zero if:

(1) Loses BSP. The skier loses BSP during the crossing but retains the handle, e.g. sit or Fall/tumble up.

(2) Crossing Back. The skier turns back during the crossing and exits the wake without first having crossed over the entire wake in BSP. The skier may continue crossings and scoring re-commences only from BSP outside the wake.

505: SCORING

(A) Simple Majority. The Scorers shall receive the score sheet(s) and decide the crossings to be scored, based on a majority from among the Event Judges' individual score sheets. Points shall be awarded for full and partial crossings made during the pass as set out in 504.

(B) Imperfect One-Foot Crossing. Downgrading an imperfect one-foot crossing to a two-foot crossing requires a majority of the Event Judges agreeing on the same fault zone for that crossing. The three fault zones shall be as follows:

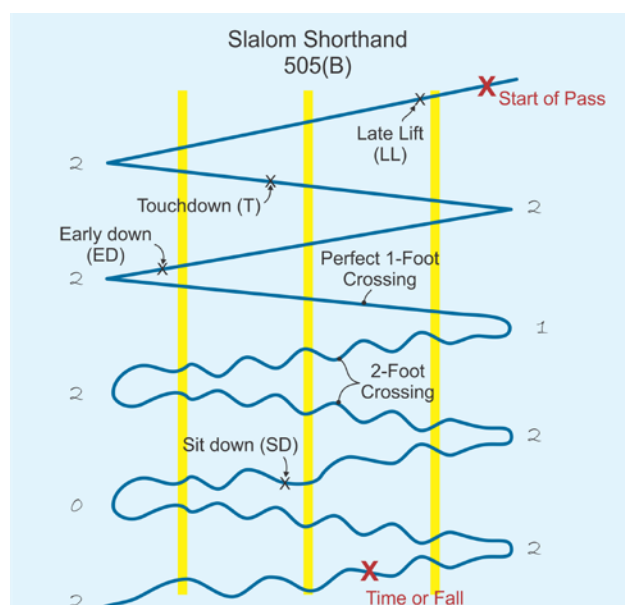

(1) Late Lift (LL). A late lift shall be recorded when the skier's lifted foot touches the water surface between the lift-off points before the supporting foot reaches the first lift-off point of the wake wave.

(2) Touch (T). A touch shall be recorded when the skier's lifted foot touches the water surface between the lift-off points while the supporting foot is between the lift-off points of the wake waves.

(3) Early Down (ED). An early down shall be recorded when the skier's lifted foot touches the water surface beyond the second lift-off point while the supporting foot has yet to clear the second lift-off point of the wake waves.

(C) No Majority. In the case of no majority on any fault zone of a one-foot crossing, the crossing shall score as a one-foot crossing.

(D) Expiration of Time. The end of scoring zone shall be determined by a majority of two or more Event Judges agreeing on the same zone.

(1) In the case of three Event Judges recording three different zones for the end of scoring zone, the end of scoring zone shall be determined from video review.

(2) Where video is not available for review, the end of scoring zone shall be determined by the highest zone that has an agreement between two Event Judges.

506: OFFICIALS

(A) Recording. Event Judge(s) shall watch and using slalom shorthand shall independently record the identity and success of each crossing made by the skier as it's performed and note the exact position of the skier at the start and end of the pass.

(B) Continue Recording. Event Judge(s) shall continue to record crossings made after the expiry of the 15 seconds, regardless of speed or path of the towboat.

(C) After Pass Ends. Supplements to this record for which there was insufficient opportunity during the pass or the correction of writing errors or misconceptions can be made after the pass ends, but only before the sheet is discussed for scoring in the boat or handed over to the Scorers, except as permitted in video review [1303(A)].

(1) Additions or corrections shall not be made to the score sheet once the sheet has been discussed or handed over to the Scorers.

(2) Except as permitted in 506(E) or 1010, there shall not be any communication of the score sheets with the other Event Judges until after the event's protest period has expired.

(D) Judging. The Event Judge(s) shall independently decide and record with respect to each crossing the following:

(1) Where the crossing started and ended.

(2) Whether the crossing was a two-foot, imperfect one-foot, or perfect one-foot crossing.

(3) If the crossing was an imperfect one-foot crossing i.e. the skier lifted up late, touched down between the lift-off points of the wake, or put down early, this shall be clearly marked on the score sheet at the place where it occurs.

(4) Whether the crossing was a partial one-foot or partial two-foot crossing.

(5) The reason for the ending if a partial crossing.

(6) If the crossing was performed according to the rules.

(E) Boat Scoring. When authorized by the Chief Judge and only after completing their sheets, the Event Judges shall communicate with each other to arrive at a majority and to convey that provisional score to the Scorer.

CHAPTER 6: START TRICKS

601: GENERAL

- (A) **Number of Passes.** In each round, each skier shall be allowed two passes through the trick course during which the skier can earn start points at the beginning of each pass.
- (B) **Skier Persists.** The skier is permitted to persist with the start until the towboat passes the shutdown buoy and comes to rest.
- (C) **Credited.** The skier shall be credited with the **first successfully completed** start trick.
- (D) **One-Foot Start.** During a one-foot start, the lifted foot shall not support the weight of the skier before One-Foot BSP has been recognized. If, in the opinion of the event judge(s), the lifted foot becomes a supporting foot before One-Foot BSP has been recognized, the start shall be downgraded to the two-foot start only if the criteria of the two-foot version in accordance with 604 was satisfied.

602: SCORING

To receive credit for two starts in a round, the skier shall successfully perform two different starts listed in Rule 604 the Start Points Table.

Start Points - 602				
	Two Feet	One Foot	Flyer Bonus	Tower Bonus
Front Deep	50	100	50	100
Front Toe-Up		400	50	150
Front Tumble	100	150	50	100
Back Deep	200	500	100	200
Back Toe-Up		450	50	200
Back Tumble	400	700	100	200
Back Line	400		100	250

- (A) **Successful Start.** The points for a successful start trick shall be credited whether or not the subsequent trick pass is credited.
- (B) **Failed Start.** A failed start trick does not affect the scoring of subsequent pass trick.

(C) **Repeated Two-Foot Start.** Where a two-foot start has been repeated, only the higher-paying start shall be credited.

(D) **Repeated One-Foot Start.** Where a one-foot start has been repeated:

- (1) The higher-paying start shall be credited.
- (2) The repeated start shall be downgraded to a two-foot start and credited if the criterion of the two-foot version was satisfied.

603: DOCK, TOWER, OR LAND START (FLYER)

(A) **Dock, Tower, or Land Start (Flyer).** A dock, tower, or land start (flyer) shall only be permitted on the first pass.

(B) **Towboat Action.**

- (1) **Remain at Starting Dock.** The towboat shall remain at the starting dock, tower, or land until the 10-second call.
- (2) **At 10-Second Call.** At the 10-second call from the Communicator Judge, the towboat shall go into and remain in gear at idle or at requested speed until the "OK" or "STOP" command is received from the skier.

(C) **Credit Conditions.** To receive credit for a dock, tower, or dry-land (flyer) start, the following shall be complied with:

- (1) **Boat Movement.** The skier's instructions shall ensure that the towboat is accelerating when he hits the water after leaping off the dock, land, or tower.
- (2) **Takeoff.** The skier shall take at least one hop, skip, or step on the dock, tower, or land and propel himself up and out from the dock, tower, or land; there shall be an instant when the whole of the skier is clearly above the point of takeoff. During a dry-land start, the skier may contact the water before propelling himself up and out.

(3) **Backward Dock or Tower Start.** The skier shall be facing in the direction of travel of the towboat and is not permitted to trail the handle and line between the legs. On signaling his readiness to go by the “OK” command, the skier shall complete the handle pass while the skier is in the air, while at the same time turning to the backward position prior to landing on to the water.

604: START TRICK DESCRIPTIONS

The skier shall attain BSP by means of any of the following starts:

- (A) **Front Deep-to-Two.** On the “OK” command, the skier shall be pulled feet first up-to-speed according to his instructions with his body facing upwards. The skier shall then place both feet onto the water and raise himself to forward BSP.
- (B) **Front Deep-to-One.** On the “OK” command, the skier shall be pulled feet first up-to-speed according to his instructions with his body facing upwards. The skier shall then place one foot onto the water and raise himself to forward to One-Foot BSP. The lifted foot shall not support weight of the skier before One-Foot BSP has been recognized. If the skier fails to satisfy 601(E) before One-Foot BSP has been recognized the start shall be downgraded to a front deep-to-two provided it meets the requirements of 604(A).
- (C) **Back Deep-to-Two.** On the “OK” command, the skier shall be pulled feet first up-to-speed according to his instructions with his body facing downwards and the handle held behind his back. The skier shall then place both feet onto the water and raise himself to backward BSP.
- (D) **Back Deep-to-One.** On the “OK” command, the skier shall be pulled feet first up-to-speed according to his instructions with his body facing downwards and the handle held behind his back. The skier shall then place one foot onto the water and raise himself to backward One-Foot BSP. If the skier fails to satisfy 601(D) before One-Foot BSP has been recognized the start shall be downgraded to a back deep-to-two provided it meets the requirements of 604(C).
- (E) **Front Tumble-to-Two.** On the “OK” command, the skier shall be pulled headfirst with his legs trailing behind him up-to-speed according to his instructions. The skier may come out of the water on either his stomach or back. While on his back, the skier shall then swing his legs round from the trailing position to the forward position and raise himself to forward Two-Foot BSP. During the rotation the skier may hesitate, pause, overshoot, or reverse direction.
- (F) **Front Tumble-to-One.** On the “OK” command, the skier shall be pulled headfirst with his legs trailing behind him up-to-speed according to his instructions. The skier may come out of the water on either his stomach or back. While on his back, the skier shall then swing his legs round from the trailing position to the forward position and then place one foot onto the water and raise himself to forward One-Foot BSP.
- During the rotation the skier may hesitate, pause, overshoot, or reverse direction. If the skier fails to satisfy 601(E) before One-Foot BSP has been recognized the start shall be downgraded to a front tumble-to-two provided it meets the requirements of 604(E).
- (G) **Back Tumble-to-Two.** On the “OK” command, the skier shall be pulled headfirst, on his back, side or front, with his legs trailing behind him while holding the handle behind his back, up-to-speed according to his instructions. While on his stomach the skier shall swing his legs round from the trailing position to the forward position and raise himself to backward Two-Foot BSP. During the rotation the skier may hesitate, pause, overshoot, or reverse direction.
- (H) **Back Tumble-to-One.** On the “OK” command, the skier shall be pulled headfirst, on his back, side or front, with his legs trailing behind him while holding the handle behind his back, up-to-speed according to his instructions. While on his stomach the skier shall swing his legs round from the trailing position to the forward position and raise himself to backward One-Foot BSP. During the rotation the skier may hesitate, pause, overshoot, or reverse direction. If the skier fails to satisfy 601(D) before One-Foot BSP has been recognized the start shall be downgraded to a back tumble-to-two provided it meets the requirements of 604(G).

(I) **Front Rope-on-Foot.** On the “OK” command, the skier shall be pulled feet first up-to-speed according to his instructions. His body shall be facing upwards, pulled entirely by the foot in the toe-strap of his handle. Both feet are permitted to touch the toe-strap. The skier shall then place his free foot onto the water and raise himself into forward Rope-on-Foot BSP.

The hands are permitted to touch the water surface or spray during the start. The hands shall not touch the handle during the entirety of the start. The skier may steady himself by holding the leg while the towboat accelerates and/or when or rising into BSP. The hands shall be seen to be clear of the handle and the water surface long enough for recognition. Subsequent recovery of the handle is not a requirement.

(J) **Back Rope-on-Foot (Toe-Up).** On the “OK” command, the skier shall be pulled feet first up-to-speed according to his instructions. His body shall be facing upward or downward, pulled entirely by the foot in the toe-strap of his handle. Both feet are permitted to touch the toe-strap. From a position on his stomach, the skier shall place his free foot onto the water and raise himself in to backward Rope-on-Foot BSP.

The hands are permitted to touch the water surface or spray during the start. The hands shall not touch the handle during the entirety of the start. The hands shall be seen to be clear of the handle and the water surface long enough for recognition. Subsequent recovery of the handle is not a requirement.

(K) **Line Back Deep.** On the “OK” command, the skier shall be pulled feet first up to speed according to their instructions with his body facing downwards and the handle being held with both hands between their legs in the line position. The skier shall then place both feet onto the water and raise himself to Line BSP.

CHAPTER 7: PASS TRICKS—GENERAL REQUIREMENTS

701: PASSES

In each round, each skier shall be allowed two 15-second passes through the tricks course during which the skier can earn pass trick points in accordance with 712.

702: START OF TIME AND RECORDING

(A) First Movement. The Event Judge(s) shall start the 15-second timing device and recording at the skier's first movement toward any pass trick listed in Chapter 8, as per any instructions declared in accordance with 303(F)

(B) Changing Grip. The action of changing the grip or how the handle is held in preparation for commencing a trick (e.g. taking the handle between the legs in preparation for line position tricks, holding the handle by the toe strap in preparation for neck or teeth tricks) shall never be considered a "first movement" towards a trick.

(C) Incidental Motions. Incidental movements, such as but not limited to, a celebratory fist pump after the start, removing weed from feet, adjusting neck brace or wiping the skiers face/head, shall never start the 15-second timer.

703: END OF SCORING

(A) Audible Timing Device. The sounding of an audible timing device shall mark the end of the 15-second pass.

(B) Shutdown Buoy. If the towboat passes the shutdown buoy before the 15 seconds have elapsed, the Driver shall smoothly close the throttle and maintain a safe path until the towboat stops. The skier is free to continue executing tricks while the towboat is slowing down and the Event Judges will continue to record them, noting when the timing device sounds the end of the 15 seconds.

704: CREDIT FOR TRICKS

Pass tricks are credited in two phases, according to technical and logical criteria.

(A) Technical Criteria.

- (1) The technical criteria are the descriptions contained in Chapter 8 and are applied by the Event Judges.
- (2) Tricks are assessed in isolation without regard to what happens before or after them.

(B) Logical Criteria. After technical approval, tricks are examined in the light of logical criteria, which involve the relationships to other tricks and the setting of the trick in the two-pass round.

705: SKIER RESPONSIBILITY

(A) Make Action Clear. The skier shall make each action and movement clear to the Event Judge(s), taking into account the distance, water spray, speed of movement and other factors affecting the ability of the Event Judge(s) to discern the prescribed actions when performing a trick.

(B) Maintain BSP. The skier shall display appropriate BSP at the start, during, and the end of all tricks.

(C) Equipment. It is the skier's responsibility to declare equipment pursuant to Rule 303(B).

706: LOSS OF BSP

(A) Fall During Trick. If a skier Falls prior to the trick being recognized, the trick will not be credited.

(B) Loss of BSP and Recovery via Tumble Turn.

- (1) If the skier loses BSP prior to the trick being recognized and recovers to BSP with less than a 90 degree tumbleturn, the trick may be credited, the tumbleturn recovery shall not be credited and the skier may continue his trick pass.
- (2) If the skiers loses BSP prior to the trick being recognized and recovers to BSP with a greater than 90-degree tumbleturn, neither the trick nor tumbleturn recovery shall be credited but the skier may continue his trick pass.

- (3) If the skier loses BSP between tricks due to neither trick but is able to regain BSP, the skier may continue his trick pass.

707: REPEATING FAILED TRICKS

A failed trick may be immediately reattempted until the trick has been credited or time expires. The turn rotation rule 803 does not apply when repeating a failed turn trick.

708: TRICK AFTER EXPIRATION OF TIME

Tricks not completed before the end of the pass shall not be credited. Tricks commenced after expiry of time shall not be considered and shall bear no influence in deliberations of the validity of the last trick completed in time.

709: REVERSE TRICKS

- (A) **Reverse Trick.** A reverse trick shall immediately follow the basic trick.
- (B) **Basic and Reverse.** A basic and reverse performed in different passes shall not both score.
- (C) **Failed Basic.** The reverse shall not be disallowed simply because it follows an attempted basic trick which has not been credited or because the basic trick is a repeated trick.
- (D) **Credit Basic and Reverse.** A basic and reverse trick correctly performed, shall be eligible for scoring even if one or both are repeat(s) of trick(s) previously performed in the same or the other pass. Such previously scored trick(s) shall then be annulled unless this conflicts with highest scoring sequence rule 712(B).
- (E) **Opposite Foot/Hand.** The reverse of a one-foot, one-foot hop, rope-in-teeth one-foot, Rope-on-Neck one-foot, rope-on-foot, rope on foot turn, sit down-stand up one-foot, wave, one-foot-wave, or tumbleturn one-foot trick shall be on the opposite foot/hand.

710: SIMULTANEOUS TRICKS

In the event that two tricks are performed simultaneously, only the higher scoring of the two tricks shall score unless that trick has previously been scored, in which case the lower-scoring trick shall score.

711: PRECURSORY TRICKS

- (A) **One-Foot.** When executing a one-foot or a one-foot-wave trick, if the skier makes any movement toward a hop, one-foot-wave, rope-on-foot, or one-foot turn, then that one-foot or one-foot-wave trick shall not be credited as a trick, regardless of the success or failure of the subsequent trick.
- (B) **Wave.** When executing a wave trick, if the skier makes any movement towards any other trick then that wave trick shall not be credited as a trick, regardless of the success or failure of the subsequent trick.
- (C) **One-Foot BSP.** Continuing to hold one-foot, wave or one-foot wave BSP after completing any trick shall never be paid as a one-foot, wave or one-foot-wave trick, regardless of the success or failure of the previous trick.
- (D) **Rope-on-Foot.**
- (1) When executing a rope-on-foot, once the skier makes any move toward a rope-on-foot turn, or **Rope-on-Foot Sit Down Stand Up**, then a rope-on-foot trick shall not be credited, regardless whatever happens to the subsequent trick.
 - (2) Holding Rope-on-Foot BSP after completing a rope-on-foot turn trick shall never be paid as a rope-on-foot, whether or not the turn trick succeeded.
 - (3) To receive credit for a rope-on-foot trick immediately prior to or following a rope-on-foot turn, the foot shall be removed completely from the toe-strap and then replaced to commence the second trick.

712: SCORING—TRICK POINT VALUES

(A) Scoring Process. The Scorers shall receive the score sheets and points shall be awarded for tricks made during the pass in accordance with the Trick Point Values Table 712(A). In the event of a discrepancy, the Scorers shall decide the tricks to be scored on the basis of a majority from among the Event Judge’s individual score sheets as to:

- (1) The tricks performed.
- (2) If the tricks were performed according to the logical rules governing those tricks.
- (3) If any downgrades apply.
- (4) The last trick completed before time expired.

(B) Highest Scoring Sequence. The highest scoring sequence of tricks that complies with all rotation rules shall be used for scoring a trick pass.

	Trick Point Values - 712(A)			
	Surface Tricks		Wake Tricks	
General	Two Foot	One Foot	Two Foot	One Foot
Hop Backward	100*		150§	250§
Hop Forward	20*		30§	100§
Knee Skiing	30			
One Foot Backward		100*		
One Foot Forward		30		
One Hand One Foot Backward		150		
One Hand One Foot Forward		50		
Rope in Teeth	20	50		
Rope on Neck	20	50		
Side Slide - Backward	450§			
Side Slide - Forward	200§			
Side Slide Switch	600§			
Sit Down/Stand Up	20	40		
Toe Sit Down/Stand Up		200		
Somersault (Flip)	700		850	1200
Toe Hold Backward		200		
Toe Hold Forward		100		
Tumble 180	50	100		
Tumble 360	50	100		
Wave	10			
Turns - Surface				
180 Back-to-Front	200	500	450	800
180 Front-to-Back	250	400	700	900
360 Back-to-Back	500	1000	1200	1600
360 Front-to-Front	500	1000	1200	1600
540 Back-to-Front	800	1500		
540 Front-to-Back	800	1500		
720 Back-to-Back	1000	1900		
720 Front-to-Front	1000	1900		
Turns - Step-Over				
Step-Over 180 Back-to-Front	450		700	
Step-Over 180 Front-to-Back	600			
Step-Over 360 Back-to-Back	1100			
Step-Over 360 Front-to-Front	1100			
Step-Over 540 Back-to-Front	1700			
Step-Over 540 Front-to-Back	1700			
Step-Over 720 Back-to-Back	2200			
Step-Over 720 Front-to-Front	2200			
Turns - Rope-on-Foot				
Toe Back-to-Front		900		1700
Toe Back-to-Front Toe Start Recovery		300		
Toe Front-to-Back		400		800

*Bonus Trick - 713(A)
 Front Hop 1-foot 50
 Back Hop 1-foot 100
 Back Hop 2' Line 100
 Back Hop 1' Line 200
 Line 1-foot 100
 § One only i.e. no reverse

Start Points - 602			
	Two Feet	One Foot	Tower Bonus
Front Deep	50	100	50
Front Toe-Up	400	50	150
Front Tumble	100	150	50
Back Deep	200	500	100
Back Toe-Up	450	50	200
Back Tumble	400	700	100
Back Line	400	100	250

Note: Full page view in back of book.

(C) Previously Performed One-Foot Trick. A correctly performed one-foot trick previously performed in the same or the other pass shall be down-graded to a two-foot trick if it satisfies all the

criteria for the two-foot version. The previously scored trick shall remain unless this conflicts with highest scoring sequence rule 712(B).

713: BONUS ACTIONS

(A) Bonus Values. The following pass tricks carry a bonus value (basic and reverse one foot only), which are treated as separate from the whole trick and shall be judged and scored as bonuses:

- (1) Hop-Front (one foot)—50 points*
- (2) Hop-Back (one foot)—100 points*
- (3) Hop-Back (Line BSP)—100 points
- (4) Hop-Back One Foot (Line BSP)—200 points*
- (5) One Foot (Line BSP)—100 points*

*Bonus is permitted for both feet, thus allowing two one-foot hops with bonus credit.

(B) Double Credit. A skier cannot be credited with a trick and then credited again with the repeated trick and the bonus. When a skier performs a trick and repeats the trick with the bonus, the skier will only be credited with the bonus points for the repeated trick

714: OFFICIALS

(A) Recording. The Boat Judge(s) shall watch and independently record each trick attempted by the skier and decide with respect to each trick:

- (1) If it was performed in accordance with the technical rules governing that trick.
- (2) If any downgrades apply to the trick.
- (3) If the trick was completed before **expiry of time.**

(B) Written Record. The Event Judge(s) shall make a written record, in accordance with the Trick Shorthand Table, of the identity and success or failure of each trick as it’s performed. This record shall note the direction of a turn, bonus actions, and on which foot when a one-foot trick has been performed.

Tricks Shorthand Table - 714(B)									
	Surface Tricks				Wake Tricks				Wake-to-Wake
	Two Foot		One Foot		Two Foot		One Foot		
	Basic	Rev	Basic	Rev	Basic	Rev	Basic	Rev	
General									
Hop	Λ		Λ>	<Λ	Λ _v				Λ _w
Knee Skiing	K								
One Foot			>	<					
Rope in Teeth	T		T>	<T					
Rope on Neck	N		N>	<N					
Side Slide-Backward	BSS								
Side Slide-Forward	SS								
Side Slide Switch	SSS								
Sit Down Stand Up	SD		SD>	<SD					
Toe Sit Down Stand Up			CD	DC					
Somersault (Flip)	O				O _v				O _w
Toe Hold			C.	.C					
Tumble 180	⤵	⤴	⤵>	<⤴					
Tumble 360	⤶	⤷	⤶>	<⤷					
Wave	W.	.W	W>	<W					
Turns									
180° Turn	1.	.1	1>	<1	1 _v	v1	1> _v	v<1	1 _w
360° Turn	3.	.3	3>	<3	3 _v	v3	3> _v	v<3	3 _w
360° OH Turn	⌒	⌒							
540° Turn	5.	.5	5>	<5					
720° Turn	7.	.7	7>	<7					
Step Turn 180°	S1	1S			S _v	vS			
Step Turn 360°	S3	3S							
Step Turn 540°	S5	5S							
Step Turn 720°	S7	7S							
Toe Back-to-Front Ft-to-Ft			C ₁	.1C			C _v	vC	
Toe Back-Front Toe Start Rec			C ₂	.2C					
Toe Front-to-Back Ft-to-Ft			C ₁	.1C			C _v	vC	

Note: Full page view in back of book.

(1) Supplements to this record for which there was insufficient opportunity during the pass or the correction of writing errors or misconceptions can be made after the pass ends, but only before the sheet is discussed for scoring in the towboat or handed over to the Scorers, except as permitted in video review [1303(A)].

(a) Additions or corrections shall not be made to the score sheet once the sheet has been discussed or handed over to the Scorers.

(b) Except to determine the last trick in time as permitted in 714(D), to provide provisional results as permitted in 1010 or for in boat scoring as permitted in 714(E), there shall not be any communication of the score sheets with the other Event Judges until after the event's protest period has expired.

(C) **Continue Recording.** The Boat Judge(s) shall continue to record tricks made after the expiry of the 15 seconds, regardless of speed or path of the towboat.

(D) **Last Trick in Time.** Between passes, the skier is permitted to ask the Event Judges the last trick in time.

(E) **Boat Scoring.** If authorized by the Chief Judge, and only after completing their sheets, the Event Judges shall communicate with each other to arrive at a majority and to convey that decision to the Scorer.

715: DOWNGRADES

(A) **Tumbleturn Start or Pass Tricks.** A one-foot tumbleturn not meeting the one-foot stand up requirements shall downgrade to two-foot tumbleturn provided it has satisfied all criteria for a two-foot tumbleturn [801(H)].

(B) **One-foot Turns.** Should the skier fail to start and end a one foot turn in one-foot BSP and/or the lifted foot does not remain clear of the water's surface throughout the entirety of the turn in accordance with 802(G), that turn shall downgrade to a two-foot turn provided it has satisfied all criteria for a two-foot turn unless this conflicts with 712(B), in which case it shall receive no credit.

(C) Wake Tricks.

(1) Wake tricks may downgrade to a surface trick if the wake criteria have not been met, provided it has satisfied all criteria for the surface trick in accordance with Chapter 8.

(2) Wake-to-Wake tricks may downgrade to a wake or surface trick if the wake-to-wake or wake criteria have not been met, provided it has satisfied all criteria for a wake or surface trick in accordance with Chapter 8.

716: ONE ATTEMPT FOR CREDIT

For trick credit, at the conclusion of each trick or trick recovery [706(B)], the skier shall achieve BSP in one attempt and shall meet all of the following requirements:

(A) **Foot Plant.** The skier may stall or hesitate after the initial foot/feet plant but is not permitted to lose that plant and replant the foot/feet.

(B) **Re-Sit.** Once the skier has raised himself from the surface of the water, the skier is not permitted to re-sit on the water until BSP has been recognized.

(C) **No Credit.** Should the skier replant the foot/feet or re-sit in this first attempt to gain BSP, the pass trick shall not be credited even if the trick is subsequently completed.

CHAPTER 8: PASS TRICK DESCRIPTION

801: GENERAL PASS TRICKS

(A) **Wave.** Commencing from Neutral BSP, the skier shall release his hand and raise that entire hand above the level of the shoulder.

(B) **Sit Down-Stand Up.**

(1) **Two Foot.** Commencing from Neutral BSP the skier shall sit down on the water surface, clearly showing his feet to be clear of the water surface and then raise himself to forward BSP.

(2) **One Foot.** Commencing from Neutral BSP the skier shall sit down on the water surface, clearly showing his feet to be clear of the water surface. The skier shall then place one foot onto the water and raise himself to forward One-Foot BSP. Basic and reverse shall be allowed in addition to the two-foot version.

(C) **One-Foot (Forward or Backward).** Commencing from Neutral BSP the skier shall raise one foot and demonstrate forward or backward One-Foot BSP.

(D) **One-Foot-Wave.** Commencing from Neutral BSP the skier shall simultaneously display One-Foot BSP and a wave trick. The lifted foot contacting the rope shall not disallow the trick.

Note placing the foot into the toe strap is prohibited. See Rule 711.

(E) **Knee Ski.** Commencing from Neutral BSP the skier shall go down onto his shins/knees; subsequent recovery of BSP is not a requirement to complete the trick for credit.

(F) **Rope-on-Neck**

(1) **General.**

- (a) The hands shall be released from the handle and be clearly visible simultaneously.
- (b) To receive credit for a two-foot Rope-on-Neck trick in a series, it shall always precede the one-foot tricks.

(c) No re-gripping of the handle is permitted in between performing the neck two-foot, one-foot, and reverse tricks.

(d) Should the skier re-grip the handle during a series of rope on neck tricks, the skier shall remove the handle from the neck and re-initiate the series to receive credit for the full series of tricks.

(e) To receive credit for one-foot Rope-on-Neck tricks in a series, they shall always follow the two-foot trick.

(2) **Two-Feet.** While using a rope-on-foot trick handle the skier shall place the handle over the head and behind the neck and then the skier shall release the hands completely from any part of the handle or rope while maintaining BSP.

(3) **One-Foot.** While maintaining two-foot Rope-on-Neck BSP, the skier shall raise one foot and demonstrate one-foot Rope-on-Neck BSP.

(G) **Rope-in-Teeth.**

(1) **General.**

(a) The hands shall be released from the handle and be clearly visible simultaneously.

(b) To receive credit for a two-foot Rope-in-Teeth trick in a series, it shall always precede the one-foot tricks.

(c) No re-gripping of the handle is permitted in between performing the Rope in Teeth two-foot, one-foot and reverse tricks.

(d) Should the skier re-grip the handle during a series of Rope in Teeth tricks, the skier shall remove the handle from the teeth and re-initiate the series to receive credit for the full series of tricks.

(e) To receive credit for one-foot Rope-in-Teeth tricks in a series, they shall always follow the two-foot trick.

(2) **Two-Feet.** The skier shall place the teeth piece in his mouth. The skier shall then release the hands from any part of the handle while maintaining Rope-in-Teeth BSP.

(3) **One-Foot.** While maintaining two-foot Rope-in-Teeth BSP, the skier shall raise one foot and demonstrate one-foot Rope-in-Teeth BSP.

(H) Tumbleturns.

(1) General.

- (a) The reverse of a two-foot tumbleturn shall be rotated in the opposite direction.
- (b) The reverse of a one-foot tumbleturn shall be both rotated in the opposite direction and to the opposite foot.
- (c) During the rotation of a tumble, the skier may hesitate, pause, overshoot, or reverse direction.
- (d) The initial direction of rotation shall establish the creditable direction of the tumble turn.

(2) 180-Degree Tumbleturn.

- (a) **Two-Feet.** Commencing from forward BSP, the skier shall lower himself to the water and execute a 180-degree revolution on his back arriving in a head-first position. The 180-degree position is considered achieved when the feet of the skier are judged to have reached or passed the line of the boat path. The skier will then stop, and reverse the direction of the turn, return to the forward facing position and regain BSP
- (b) **One-Foot.** The skier shall perform a 180-degree tumbleturn and stand up on one foot to One-Foot BSP.

(3) 360-Degree Tumbleturn.

- (a) **Two-Feet.** Commencing from forward BSP, the skier shall lower himself to the water and execute a 360-degree revolution on his back returning to the forward facing position and regain BSP.
- (b) **One-Foot.** The skier shall perform a 360-degree tumbleturn and stand up on one foot to One-Foot BSP.

(I) Hop.

(1) General.

- (a) **Two-Foot.** Commencing from Neutral BSP the skier shall jump from the surface of the water into the air and land in BSP. During the jump the skier shall be completely clear of the water surface.
- (b) **One-Foot.** Commencing from One-Foot BSP the skier shall jump from the surface of the water into the air and land in One-Foot BSP. During the jump the skier shall be completely clear of the water surface. Basic and reverse shall be allowed.

(2) Wake Hop.

- (a) **Two-foot.** Commencing from Neutral BSP the skier shall jump over the wake wave and land on the other side of the same wake wave in BSP. A single-wake hop can be performed from either inward or outward; no reverse is permitted.
- (b) **One-foot.** Commencing from One-Foot BSP, the skier shall jump over the wake wave and land on the other side of the same wake wave in One-Foot BSP. A single-wake hop can be performed from either inward or outward; no reverse is permitted.

(3) Wake-to-Wake Hop.

- (a) **Two-foot.** Commencing from Neutral BSP the skier shall jump the entire wake and shall be completely clear of the water, landing feet first outside the second Wake Crest. No reverse is permitted.
- (b) **One-foot.** Commencing from One-Foot BSP outside the wake, the skier shall jump the entire wake and shall be completely clear of the water landing foot first outside the second Wake Crest and the lifted foot shall never touch the water until after One-Foot BSP has been recognized. No reverse is permitted.

- (J) Rope-on-Foot.** Commencing from Neutral BSP the skier shall place one foot in the toe-strap. With his weight supported by the foot on the water, the skier shall then release his hands completely from any part of the handle so that the handle is held by only the lifted foot and in accordance with Rope-on-Foot BSP. The hands shall be seen to be clear of the handle and the water surface long enough for recognition. Subsequent recovery of the handle is not a requirement.
- (K) Rope-on-Foot Sit Down Stand Up.** Commencing from Neutral BSP the skier shall achieve Rope on Foot BSP. The skier shall then sit down on to the water surface clearly showing both feet to be clear of the water and then raise himself back up to Rope on Foot BSP. The hands shall not touch the handle during the entirety of the trick. Subsequent recovery of the handle is not a requirement.
- (L) Side-Slide.**
- (1) Forward.** Commencing from forward BSP, the skier shall rotate in one continuous movement to side-slide BSP.
 - (2) Backward.** Commencing from backward BSP, the skier shall rotate in one continuous movement to side-slide BSP.
- (M) Switch-Stance.** Commencing from side-slide BSP, the skier shall slide both feet to the opposite position and then back to the original side-slide BSP position.
- (N) Wake Tricks.** Any rotation of a wake trick shall be completed in midair during a jump over the wake wave. The skier shall land on the other side of the Wake Crest in BSP.
- (1) The skier shall remain completely clear of the water surface during the entire trick or turn.
 - (2) While executing a wake trick, the skier may use the whole of the upslope and ski through the crest of the wave to propel himself into the air.
 - (3) Wake rope-on-foot turns shall take off and land on the foot. Water contact with any body part before the foot will disallow the trick.
- (O) Wake-To-Wake Tricks.**
- (1) Any rotation of a wake-to-wake trick shall be completed in midair during a jump off the wake wave. The skier shall land on the other side of both Wake Crests in the appropriate BSP.
 - (2) The skier shall remain completely clear of the water surface during the entire trick or turn.
 - (3) The skier may use the whole of the up-slope and ski through the crest of the wave to propel himself into the air.
 - (4) The skier shall jump high enough to bridge the entire wake and shall be completely clear of the water till clearing the second Wake Crest, landing past the lift-off point of the second Wake Crest.

802: TURN TRICKS GENERAL

- (A) Opposite Direction.** The reverse of a turn trick shall be in the opposite direction of rotation of the basic.
- (B) Between 180- or 540-Degree Turns.** Any variety of 180-degree or 540-degree turn is allowed between 180-degree or 540-degree basic and reverse turns.
- (C) Skier Touching Handle with Both Hands.** The completeness of all surface, wake, and wake-to-wake turns shall be judged with the skier touching the handle with both hands whilst displaying the appropriate BSP.
- (D) Continuous Turning Movement.** In a multiple-turn any interruption in the continuous turning movement shall terminate the trick at that point and it shall score zero. A variation in the speed of rotation shall not constitute an interruption of the turn however loss of BSP before the completion of rotation shall constitute an interruption of the turn.
- (E) Maximum Multiple Surface Turns.** No more than six multiple-surface-turns shall be scored in any round.
- (F) Maximum Step-Over Turns.** No more than four step-over multiple-turns shall be scored in any round.
- (G) One-Foot Turns.** One-foot turns shall start and end in One-Foot BSP and the lifted foot shall remain clear of the water's surface throughout the entirety of the turn.
- (H) Loss Of BSP.** Surface turns shall be completed on the feet. Loss of BSP prior to completion of the rotation shall disallow the trick.

803: ROTATION RULES FOR TURN TRICKS**(A) Surface Turn Tricks.**

- (1) When any surface turn (two-foot or one-foot) immediately follows any other surface turn, the rotation shall be in the opposite direction of the previous turn, except for reverse 540 and 180 turns, which can only be in the same rotation as the positional turn.
- (2) If a skier makes consecutive surface turns in the same direction with no other trick in between, they shall be treated as a Multiple Turn and shall meet the criteria for that trick to be credited.
- (3) This requirement does not apply when the skier ends an attempted one-foot turn in One-Foot BSP and then sets his foot down and raises it again for a further one-foot turn attempt.

(B) Step-Over Turn Tricks.

- (1) When a step-over turn immediately follows another step-over turn, the rotation shall be in the opposite direction of the previous turn, except for reverse 540 and 180 turns, which can only be in the same rotation as the positional turn.
- (2) If the skier makes consecutive step-over turns in the same direction with no other trick in between, they will be treated as a multiple-turn and shall meet the criteria of that trick to be credited.

804: 180 BACK-TO-FRONT**(A) Surface 180 Back-to-Front.**

- (1) **Two-Feet.** Commencing from backward BSP, the skier shall execute a 180-degree turn to forward BSP.
- (2) **One-Foot.** Commencing from backward One-Foot BSP the skier shall execute a 180-degree turn to forward One-Foot BSP.

(B) Wake 180 Back-to-Front.

- (1) **Two-Feet.** Commencing from backward BSP the skier shall execute a 180-degree in accordance with 801(M), landing in forward BSP.

- (2) **One-Foot.** Commencing from backward One-Foot BSP, the skier shall execute a 180-degree turn in accordance with 801(M), landing in forward One-Foot BSP.

(C) Wake-to-Wake 180 Back-to-Front.

- (1) **Two-Foot.** Commencing from backward BSP outside the wake the skier shall execute a 180-degree turn in accordance with 801(N), landing in forward BSP.
- (2) **One-Foot.** Commencing from backward One-Foot BSP, outside the wake the skier shall execute a 180-degree turn in accordance with 801(N), landing in forward One-Foot BSP.

805: 180 FRONT-TO-BACK**(A) Surface 180 Front-to-Back.**

- (1) **Two-Feet.** Commencing from forward BSP, the skier shall execute a 180-degree turn to backward BSP.
- (2) **One-Foot.** Commencing from forward One-Foot BSP the skier shall execute a 180-degree turn to backward One-Foot BSP.

(B) Wake 180 Front-to-Back.

- (1) **Two-Feet.** Commencing from forward BSP, the skier shall execute a 180-degree in accordance with 801(M), landing in backward BSP.
- (2) **One-Foot.** Commencing from forward One-Foot BSP, the skier shall the skier shall execute a 180-degree in accordance with 801(M), landing in backward One-Foot BSP.

(C) Wake-to-Wake 180 Front-to-Back.

- (1) **Two-Feet.** Commencing from forward BSP, the skier shall execute a 180-degree turn in accordance with 801(N), landing in backward BSP.
- (2) **One-Foot.** Commencing from forward One-Foot BSP, the skier shall execute a 180-degree turn in accordance with 801(N), landing in backward One-Foot BSP.

806: 360 FRONT-TO-FRONT**(A) Surface 360 Turns.**

- (1) **Two-Feet.** Commencing from forward BSP, the skier shall execute a continuous 360-degree turn, returning to forward BSP.
- (2) **One-Foot.** Commencing from forward One-Foot BSP, the skier shall execute a continuous 360-degree turn returning to forward One-Foot BSP.

(B) Wake 360 Front-to-Front.

- (1) **Two-Feet.** Commencing from forward BSP, the skier shall execute a 360-degree turn in accordance with 801(M), landing in forward BSP.
- (2) **One-Foot.** Commencing from forward One-Foot BSP, the skier shall execute a 360-degree turn in accordance with 801(M), landing in forward One-Foot BSP.

(C) Wake-to-Wake 360 Front-to-Front.

- (1) **Two-Feet.** Commencing from forward BSP, the skier shall execute a 360-degree turn in accordance with 801(N), landing in forward BSP.
- (2) **One-Foot.** Commencing from forward One-Foot BSP, the skier shall execute a 360-degree turn in accordance with 801(N), landing in forward BSP.

- (D) **Overhead 360 Front-to-Front.** Commencing from Forward Neutral BSP the skier shall perform a 360 rotation while passing the handle over their head. While either hand may lose contact with the handle during the rotation, the other hand must remain on the handle for the entirety of the trick. The skier shall maintain movement in the initial direction of rotation throughout the trick. The completeness of this trick shall be when the skier has returned to Forward Neutral BSP.

807: 360 BACK-TO-BACK**(A) Surface 360 Back-to-Back.**

- (1) **Two-Feet.** Commencing from backward BSP, the skier shall execute a continuous 360-degree turn, returning to backward BSP.

- (2) **One-Foot.** Commencing from backward One-Foot BSP, the skier shall execute a continuous 360-degree turn, returning to backward One-Foot BSP.

(B) Wake 360 Back-to-Back.

- (1) **Two-Feet.** Commencing from backward BSP, the skier shall execute a 360-degree turn in accordance with 801(M) landing in backward BSP.
- (2) **One-Foot.** Commencing from backward One-Foot BSP, the skier shall execute a 360-degree turn in accordance with 801(M), landing in backward One-Foot BSP.

(C) Wake-to-Wake 360 Back-to-Back.

- (1) **Two-Foot.** Commencing from backward BSP outside the wake, the skier shall execute a 360-degree turn in accordance with 801(N), landing in backward BSP.
- (2) **One-Foot.** Commencing from backward One-Foot BSP outside the wake, the skier shall execute a 360-degree turn in accordance with 801(N), landing in backward One-Foot BSP.

808: 540 TURNS**(A) Surface 540 Back-to-Front.**

- (1) **Two-Feet.** Commencing from backward BSP, the skier shall execute a continuous 540-degree turn to forward BSP.
- (2) **One-Foot.** Commencing from backward One-Foot BSP, the skier shall execute a continuous 540-degree turn to forward One-Foot BSP.

(B) Surface 540 Front-to-Back.

- (1) **Two-Feet.** Commencing from forward BSP, the skier shall execute a continuous 540-degree turn to backward Two-Foot BSP.
- (2) **One-Foot.** Commencing from forward One-Foot BSP, the skier shall execute a continuous 540-degree turn to backward One-Foot BSP.

809: 720 TURNS**(A) Surface 720 Front-to-Front.**

- (1) **Two-Feet.** Commencing from forward BSP, the skier shall execute a continuous 720-degree turn, returning to forward BSP.
- (2) **One-Foot.** Commencing from forward One-Foot BSP, the skier shall execute a continuous 720-degree turn, returning to forward One-Foot BSP.

(B) Surface 720 Back-to-Back.

- (1) **Two-Feet.** Commencing from backward BSP, the skier shall execute a continuous 720-degree turn, returning to backward BSP.
- (2) **One-Foot.** Commencing from backward One-Foot BSP, the skier shall execute a continuous 720-degree turn, returning to backward One-Foot BSP.

810: STEP-OVER TURNS**(A) General.** To receive credit for a Step-Over turn all of the following conditions shall be met:

- (1) **Leg Over Rope.** The turn shall be made on one foot. The traveling foot/leg shall start passing over the rope before the turn has been completed.
- (2) **Water Contact.** The foot that passed over the rope shall contact the water before any other body part.
- (3) **Completion.** The trick shall be completed with the skier displaying the appropriate BSP.
- (4) **Accidental Contact.** Accidental contact with the rope or spray during the step over will not disallow the trick.

(B) Wake-Turn. In a step-over wake turn the leg shall pass over the rope and the turn shall be completed while the skier is in the air.**(C) Multiple Step-Over.** In a Multiple-Step-Over-Turn both legs shall pass over the rope in succession, changing feet at mid-point.**(D) Step-Over Turn Tricks**

- (1) **180 Step-Back-to-Front.** Commencing from Line BSP, the skier shall execute a 180-degree turn while stepping over the rope to forward BSP.

(2) **Wake 180 Step-Back-to-Front.** Commencing from Line BSP, the skier shall jump over the wake wave, step over the rope, and turn 180-degrees commencing from the air, landing on the far side of that wake wave in forward BSP.

(3) **180 Step-Front-to-Back.** Commencing from forward BSP, the skier shall execute a 180-degree turn while stepping over the rope to Line BSP.

(4) **Wake 180 Step-Front-to-Back.** Commencing from forward BSP, the skier shall jump over the wake wave, step over the rope, and turn 180-degrees commencing from the air, landing on the far side of that wake wave in Line BSP.

(5) **360 Step-Back-to-Back.** Commencing from BSP, the skier shall execute a continuous 360-degree turn, stepping over the rope as the skier goes from back to front and again as the skier comes from front to back, returning to Line BSP.

(6) **360 Step-Front-to-Front.** Commencing from forward BSP, the skier shall execute a continuous 360-degree turn, stepping over the rope as the skier goes from front to back and again as the skier comes from back to front, returning to forward BSP.

(7) **540 Step-Back-to-Front.** Commencing from Line BSP, the skier shall execute a continuous 540-degree turn, stepping over the rope as the skier goes from back to front, front to back, and back to front, returning to forward BSP.

(8) **540 Step-Front-to-Back.** Commencing from forward BSP, the skier shall execute a continuous 540-degree turn, stepping over the rope as the skier goes from front to back, back to front, and front to back, returning to Line BSP.

(9) **720 Step-Back-to-Back.** Commencing from Line BSP, the skier shall execute a continuous 720-degree turn, stepping over the rope as the skier goes from back to front, front to back, back to front, and front to back, returning to Line BSP.

(10) 720 Step-Front-to-Front. Commencing from forward BSP, the skier shall execute a continuous 720-degree turn, stepping over the rope as the skier goes from front to back, back to front, front to back, and back to front, returning to forward BSP.

811: ROPE-ON-FOOT TURN FEET-TO-FEET

(A) Back-to-Front. Commencing from backward Rope-on-Foot BSP, the skier shall execute a 180-degree turn to forward Rope-on-Foot BSP.

(B) Front-to-Back. Commencing from forward Rope-on-Foot BSP, the skier shall execute a 180-degree turn to backward Rope-on-Foot BSP.

(C) Taking Handle. Taking the handle before the trick has been recognized shall disallow the trick.

(D) Feet-to-Feet. The trick shall be performed feet to feet until Rope-on-Foot BSP has been recognized for credit.

812: ROPE-ON-FOOT TURN TOE-START RECOVERY

(A) Back-to-Front. Commencing from backward Rope-on-Foot BSP, the skier shall execute a 180-degree turn to the forward position and shall stand up to regain Rope-on-Foot BSP from a seated position. The skier's hands must be clear of the handle throughout the trick.

(B) Taking Handle. Taking the handle before the trick has been recognized shall disallow the trick.

813: SOMERSAULT

(A) General.

(1) To receive credit, the plane of rotation shall be vertical like a fan blade, so that during the somersault the heels pass directly over the head. It shall be noted that although the plane of rotation shall be vertical, it's permitted to be inclined to the towboat path.

(2) In a wake somersault, after take-off, no part of the body shall touch the water on the take-off side of the wake until the trick has been held for recognition.

(3) In a wake-to-wake somersault, after take-off, no part of the body shall touch the water inside the wake until the trick has been held for recognition. A failed wake-to-wake somersault may be credited as a wake somersault providing it meets the criteria in 813(A)(1)(2).

(4) Wake somersaults shall be performed from inside to outside of the wake except in the case of 813(A)(3).

(5) A maximum of three somersaults can be scored in any round.

(6) A reverse somersault is not allowed.

(7) Reverse wake somersaults shall only be performed from the inside to the outside of the opposite wake of the basic trick.

(8) A reverse wake-to-wake somersault shall be performed in the opposite direction to the basic trick.

(B) Somersault Tricks.

(1) Somersault. Commencing from forward BSP, the skier shall perform a somersault (heels overhead) in the air, landing on the skier's feet, butt, back or head, whereupon the skier shall regain BSP

(2) Wake Somersault. Commencing from forward BSP inside the wake the skier shall perform a somersault while jumping over one wake wave, landing on the other side of the same wake wave.

(3) Wake-to-Wake Somersault. Commencing from forward BSP outside the wake the skier shall perform a somersault while jumping over the entire wake, landing on the outside of the second wake wave.

CHAPTER 9: PROTESTS

901: PROTEST BASIS

Protests shall only be permitted for the failure of an official or Tournament Committee to comply with the rules contained in this rule book. Necessary changes to the course due to safety issues encountered after the start of the tournament shall never be grounds for a protest.

902: PROTEST PROCEDURE

Protests shall be filed by the Team representative to the Chief Judge in written form and shall comply with all of the following requirements:

- (A) **General Protests.** A written protest for a failure of tournament officials, tournament supplied equipment or the tournament committee may be filed up to 30 minutes after the event results have been officially posted.
- (B) **Protest of Safety.** A written protest for safety issues may be filed at any time.
- (C) **Protest Fee.** The written protest shall be accompanied by the approximate equivalent in U.S. currency of \$20 (USD). The protest fee will be refunded if the protest is considered reasonable by the Chief Judge, even if the protest is disallowed.
- (D) **Content of Written Protest.** The written protest shall cite the rule number(s) that apply and the facts pertaining to the protest.

903: CHIEF JUDGE DECISION

- (A) **Chief Judge Authority.** After the Chief Judge has been made aware of all the facts pertaining to a decision made by any official, the Chief Judge may then overrule that decision in order to ensure compliance with all rules. This overrule is not limited to protests and applies to any decision that in the opinion of the Chief Judge is not in compliance with the rules.
- (B) **Use of Evidence.** The Chief Judge is free to use any and all evidence he feels is applicable to effect an expeditious and correct decision.

- (C) **Communicate Decision.** The Chief Judge shall communicate this decision to the officials, skiers, and team managers involved citing all of the rules used to reach this decision.

904: REVERSE CHIEF JUDGE DECISION

Any decision taken by the Chief Judge to overrule any official(s) in accordance with 903 may be reversed providing all of the following requirements have been met:

- (A) **Filing.** The written reversal protest shall be filed within 30 minutes after event has concluded or 30 minutes after the Chief Judges' decision to overrule any official(s) have been posted, whichever is later.
- (B) **Content of Written Protest.** The reversal protest shall contain the rule number(s) that the Chief Judge has violated.
- (C) **Decision.** The Chief Judge shall as soon as practical, present the reversal protest to all Appointed Officials, the Chief Judge shall make the Appointed Officials cognizant of the facts when presenting the protest to them for consideration, i.e. present his overrule decision with the rule numbers cited and the reversal protest with the rule numbers cited.
- (D) **Two-Thirds.** Two-thirds of all Appointed Officials are required to vote in favor to reverse the Chief Judge's decision to overrule any official(s).
- (E) **Decision Posting.** Any vote that reverses the Chief Judge's decision to overrule any official(s) shall be posted as soon as possible.

905: CALCULATION ERROR

- (A) **Within Two Hours of Postings.** A request by a Team Representative for a correction of an error in the computation or input of a score within 2 hours of the posting of the event results shall not be considered a protest and a correction shall be made with the approval of the Chief Judge and Chief Scorer.

- (B) **Within One-Half Hour of Next Round.** A correction of an error in the computation or input of a score discovered by the Chief Judge or Chief Scorer may be corrected up to one-half hour before the start of the next round of that event.
- (C) **Second Round.** Any skier displaced from the Second round resulting from a correction of an error in computation or input of a score shall go on to the second round.
- (D) **Third Round.** No more than five skiers shall be permitted to advance to the third round [1910], therefore any skier displaced resulting from a correction of an error in the computation or input of a score shall not go to the third round.

CHAPTER 10: RE-RIDES

1001: RE-RIDE REQUEST

- (A) **Initiated by Event Judge or Driver.** Requests for re-rides shall be initiated by an Event Judge or Driver before the next skier starts and shall be decided as soon as practicable thereafter. The Video Operator is permitted to offer information that may have escaped the notice of the Event Judges.
- (B) **Skier or Team Representative.** The Team Representative or skier is free to draw the attention of the Event Judges to some relevant condition or circumstance affecting the granting of a re-ride that may have escaped their notice. The Event Judges shall consider such submission and act on it or not as they see fit. The Event Judges shall maintain the strictest vigilance to ensure the interests of the skier are fully respected.
- (C) **Majority.** A re-ride shall be granted when a majority of the Event Judges agree that the skier is entitled to a re-ride.
- (D) **Not to Proceed.** The Event Judges shall not proceed with the next pass unless a simple majority of them have indicated that nothing was wrong with the last pass, making an appropriate entry in the tick box on the score sheet.

1002: SCORING OF RE-RIDE

When a re-ride is taken, the re-ride shall be scored and the pass for which the re-ride was given shall be annulled.

1003: OPTIONAL RE-RIDE

- (A) **Conditions or Malfunctions.** The skier shall be offered an optional re-ride only on the pass affected when water, weather or other conditions are substantially different from their competitor's conditions or in the event of a malfunction of the tournament-supplied equipment occurs that, in the opinion of the majority of the Event Judges, unfairly affects a skier.

- (B) **Skier Instructions.** The skier shall be offered an optional re-ride, only on the pass affected, when the towboat crew failed to comply with the skier instructions given and speed tolerances in accordance with Chapter 3.

- (C) **Engine Trim Position.** Skier shall be offered an optional re-ride only on the pass affected if the engine trim position was not at the default position prior to the pass as required by 1501(B).

- (D) **Towboat Path During the Jump Event.** Skier shall be offered an optional re-ride only on the pass affected if the path of the towboat differs by more than one-half of the gate width from that requested by the skier or if the towboat enters all 3 zones within the jump course.

- (E) **Towboat Path During the Slalom Event.** During the pass the towboat shall follow a straight path, approximately down the center of the course until either the shut-down buoy is reached, the skier loses possession of the handle, or the 15 seconds expires, whichever is first.

- (F) **Towboat Path During the Trick Event.** During the pass the towboat shall follow a straight path, approximately down the center of the course until either the shut-down buoy is reached, the skier loses possession of the handle, or the 15 seconds expires, whichever is first.

- (G) **Malfunction.** Should a malfunction of the jump measuring equipment render an otherwise valid jump to be unreadable, the skier shall be offered an optional re-ride or the lowest distance readable on the screen, minus one-tenth meter [408(E)].

1004: MANDATORY RE-RIDE

- (A) **Unfair Advantage.** Skier shall have a mandatory re-ride when it's the opinion of the majority of the Event Judges that a malfunction or conditions gave the skier an unfair advantage on the pass affected.

- (B) **Start/End of Pass.** Skier shall have a mandatory re-ride if the start or end of the pass cannot be determined by the combined use of the official video and the Event Judges' sheets on the pass affected.
- (C) **Jump Event.** Skier shall have a mandatory re-ride if the speed through the jump course is judged to have exceeded the maximum course speed of 73.5 kph/45.7 mph as checked by a GPS speed-measuring device while the skier is in possession of the handle and prior to BSP being recognized after the jump [405(D)].

1005: RE-RIDES—WHEN TAKEN

- (A) **Jump Event.** Re-ride shall be taken:
- (1) **Immediately.** If a single re-ride is granted for other than temporary incapacitation [1206], that re-ride shall be taken immediately.
 - (2) **Five-Minute Rest.** If more than one re-ride is taken in any series, the skier shall have the option of a five-minute rest before recommencing his turn in accordance with 1205 (A).
- (B) **Slalom and Trick Event.** If a re-ride is granted for other than temporary incapacitation [1206], that re-ride shall be taken either immediately or the skier may elect a five minute rest period permitted in accordance with 1205(B). If the skier has elected the option of a 5-minute rest period the next skier in order shall ski, and the re-ride shall be taken at the conclusion of the skier's turn during which the 5-minute rest period expires.

1006: RE-RIDE OPTIONS—TRICK

- (A) **Start Trick.** In the event of a re-ride during the start trick portion of the pass, the skier shall have the option of:
- (1) **Repeat Start Trick Only.** Repeating the start trick while retaining the pass tricks scored during the affected pass, or:
 - (2) **Repeat Start and Trick Pass.** The entire pass for which the re-ride is given shall be annulled and scoring for the re-ride shall comprise the start trick and the pass tricks made in the 15 seconds of the re-ride pass.

- (B) **Pass Trick.** In the event of a re-ride during the pass tricks portion of the pass:

- (1) **Annulled Pass.** The 15-second pass score of the affected pass shall be annulled.
- (2) **Start Trick.** Any start trick on the affected pass, whether successful or unsuccessful, shall stand and be carried forward as the start trick score for the re-ride of that pass. On the re-ride, the skier is permitted to attain BSP by any start trick listed in 604 that he chooses, but that start shall not count for scoring purposes.
- (3) **Scoring.** Scoring for the re-ride shall comprise pass tricks made in the 15 seconds of the re-ride pass plus the start trick score carried forward from the affected pass.

1007: NOT BASIS FOR A RE-RIDE

- (A) **Top Speed Advisory.** Any top speed advisories given from the towboat during the competition shall be considered a courtesy and shall never be grounds for a re-ride or protest.
- (B) **Standard Terminology.** When preparing to start from rest, the skier shall communicate with the towboat only with the words "IN GEAR," "OK," or "STOP." The towboat shall only proceed on the "OK" command. A misunderstanding due to a departure from this standard terminology shall never be grounds for a re-ride or protest.
- (C) **Before Turn Around Time.** A skier going before the turnaround time has expired [1201(C)] shall never be grounds for a re-ride or protest.
- (D) **Rope Position.** Incorrect rope attachment height [302(A) & 303(A)] shall never be grounds for a re-ride or protest.
- (E) **Boat Speed.** The failure of the towboat to attain a speed greater than 72 kph/44.7 mph shall never be grounds for a re-ride or protest.
- (F) **Last Trick in Time.** A mistake by the Event Judges communicating the last trick in time [714(D)] shall never be grounds for a re-ride or protest.
- (G) **Provisional Score.** An error or misunderstanding on the part of the Officials in communicating provisional scores [1010] shall never be grounds for a re-ride or protest.

- (H) **Skier Lands Prior to or Past Landing Box.** A successful jump that is unreadable due to the skier landing prior to or past the video box shall never be grounds for a re-ride or protest.
- (I) **Failure of Skier's Equipment.** A failure of skier's own equipment shall never be grounds for a re-ride or protest, also see 1202(B).
- (J) **Skier's Equipment.** Once the skier declares equipment pursuant to Rule 303(B), failure of declared equipment to be in the towboat for the second pass shall not be grounds for re-ride but shall be grounds to allow the skier to return to the dock pursuant to Ruled 1202(B).
- (K) **30-Second Call.** Failure of the Event Judges to give the 30-second call shall never be grounds for a re-ride.
- (L) **Failure to Execute Leveling or Equalization Pass.** Whilst it is recommended that a Leveling Pass be taken before the start of every event it is not mandatory. Equalization Passes are at the option of the Chief Judge and only required when course conditions substantially change due to excessive turnaround time
- (M) **Engine Trim Position.** If the skier requests the engine position to be changed, this shall never be grounds for are-ride or protest, also see 1003(C).
- (N) **Slalom Handle.** Incorrect handle width in the Slalom Event [303(I)] shall never be grounds for a re-ride or protest

1008: START AND PASS INSTRUCTIONS

In the case of a re-ride, the skier's instructions for the start and/or pass may be different from those given for the annulled pass.

1009: REFUSAL TO ENTER COURSE

For reasons acceptable to the Event Judges, a competitor is permitted to refuse to enter the course in any event and shall do so by clearly throwing the handle into the air.

1010: PROVISIONAL SCORE

In the event of an optional re-ride being offered, the skier has the option of requesting a provisional score from the Communicator Judge before deciding to accept or decline the re-ride. This provisional score need not be communicated as total points but may be communicated as tricks/crossings that were and were not credited or the provisional jump distance communicated from the Video Judges.

CHAPTER 11: SAFETY

1101: SAFETY DIRECTOR

- (A) **Responsibility.** The Safety Director shall be responsible for monitoring the safe condition of all equipment and facilities and the operation of the tournament, but this shall not prevent him from delegating specific responsibilities to assistants as approved by the Chief Judge.
- (B) **Proximity.** The Safety Director shall remain near the competition area as much as possible.
- (C) **Authority.** The Safety Director shall have the authority to take whatever action is necessary, including stopping the tournament, whenever he observes a condition he believes unsafe.
- (D) **Halt Tournament.** During the competition, the Safety Director is permitted to request the Chief Judge to halt the tournament for a poll of the Event Judges in regard to a skier's actions or condition.
- (E) **Overruled by Chief Judge.** The Chief Judge is authorized to overrule any contemplated action or decision of the Safety Director, but on his own responsibility.

1102: FLOTATION AND PROTECTION

- (A) **Flotation.** A neoprene wetsuit or dry suit meeting the following requirements shall be worn by all skiers in all events:
 - (1) Be smooth, soft, and free from attachments or material likely to cause injury in a Fall.
 - (2) Be so constructed and fastened that it's unlikely to be torn loose or damaged so as to render it useless in a hard Fall.
 - (3) Float the user.
 - (4) Not be an inflatable device.
 - (5) Be constructed so as to provide adequate protection from impact damage to the ribs and internal organs.

- (B) **Suitability.** In case of doubt on the suitability of flotation, the Safety Director shall order a practical test in the water.

1103: HELMETS

- (A) **Specification.** A skier in the Jump Event shall wear a helmet of a type designed to protect the head from severe impact injury.
- (B) **Skier Loses Helmet.** If a skier loses his helmet during the start or before reaching the jump ramp, the towboat shall immediately stop, unless it's unsafe to do so. Should it be unsafe for the towboat to stop, the skier shall ski past the jump whenever possible, and this jump shall be scored as a Fall. This shall not be grounds for disqualification from the remainder of the round or event, also see 1202.
- (C) **Radio Communications.** The use of helmets fitted with radio communication capabilities is prohibited in the Jump Event.

1104: SAFETY OFFICER

- (A) **Safety Officer.** A Safety officer who is familiar with all tournament events and practice and ideally is fully trained in First Aid, Emergency Resuscitation and Water Rescue Techniques shall be on-site at all times.
- (B) **Floated to Shore.** Any skier that is unable to climb into a towboat unassisted shall be floated ashore and lifted from the water on a suitable board or stretcher.
- (C) **Into Towboat.** Under no circumstances shall an injured skier be lifted passively over the side of a towboat.
- (D) **Life Jacket.** A life jacket shall be in the towboat at all times; in the event of a serious Fall by the skier, a swimmer wearing a life jacket shall enter the water to assist the skier.
- (E) **Safety Swimmer.** During the jump event a swimmer trained in water rescue, wearing flotation, having a backboard/flotation stretcher shall be present at the jump area.

1105: DISQUALIFICATION

- (A) **Safety Compliance.** Failure of a skier to wear a wet suit, proper protection and flotation under a dry suit or helmet when required shall be cause of immediate disqualification from the event by the Safety Director [210(A)].
- (B) **Danger to Himself.** No skier shall be allowed to compete or continue to compete if, in the opinion of the Chief Judge, Safety Director and a majority of the Event Judges, his competing would be a danger to himself or to other skiers in the tournament. Whenever practical the advice of a doctor shall be obtained [210(B)].

CHAPTER 12: TIMING RULES

1201: TURNAROUND TIMES

- (A) **Set by Chief Judge.** The Chief Judge will set the turnaround time after considering the recommendation of the Tournament Director and Chief Driver.
- (B) **Responsibility of Driver.** Turnaround times between passes is the responsibility of the Driver as follows:
- (1) **Time Commences.** The time clock starts on whichever is later; the towboat or chase towboat coming off plane at the end of the course.
 - (2) **Warning.** The Driver shall notify the Event Judges at 30 seconds and 10 seconds to the expiration of the turnaround time. The Communicator Judge shall notify the skier at 30 second and 10-second to expiration of turnaround time.
- (C) **Skier Option.** Except in jump, the skier has the option to go before the turnaround time has expired.
- (D) **Equalization Pass.** When the boat exceeds the turnaround time to a degree that allows conditions to substantially change or for other unforeseen circumstances the boat may be directed by the Chief Judge to take an equalization pass.

1202: EQUIPMENT FAILURE, ONE-MINUTE

- (A) **First Pass.** If the majority of the Event Judges agree they shall grant up to 1 minute for gear changes to replace broken or damaged equipment developing or discovered just prior to the skier's pass.
- (B) **Subsequent Pass.** If the majority of the Event Judges agree, (except as to 1202(B)(1), which is mandatory) they shall grant up to 1 minute for gear changes or repair. The skier is permitted to return to the starting dock in the towboat to use the equipment minute to obtain replacement equipment in accordance with the following:
- (1) **Once the skier has made the declaration required by Rule 303(B)** the skier is permitted to retrieve equipment **not in the boat.**
 - (2) The equipment minute shall start when the towboat is safely positioned at the starting

dock. If at the expiration of the equipment minute the skier is not ready to enter the towboat from the starting dock, the skier shall forfeit his second pass.

1203: EMERGENCY, ONE-MINUTE

If at the expiration of the equipment minute [1202] the skier is not ready to start the pass, the skier shall be disqualified from further participation in that round of the event for "failure to go" in accordance with 210(F) and 201(G). The disqualification of a skier for "failure to go" shall be treated as an emergency for next skier and he shall be granted one emergency minute to prepare to ski. An additional emergency minute shall be granted for each skier in turn that is disqualified.

1204: INJURY RECOVERY, UP TO THREE MINUTES

At the discretion of the Event Judges, the skier may be granted up to three minutes to recover from a heavy fall, starting at the time of the decision to grant the recovery time. If the skier cannot recover from a heavy fall within those three minutes, he shall not be permitted to complete that round of that event.

1205: RE-RIDE, FIVE-MINUTE REST

- (A) **Jump Event.** If more than one re-ride is taken in any jump series, the skier shall have the option of a five-minute rest before recommencing his turn in accordance with 1005(A).
- (B) **Slalom and Trick Event.** The skier has the option of a five-minute rest period in accordance with 1005(B).

1206: TEMPORARY INCAPACITATION

If the skier should become temporarily incapacitated through no fault or action of his own, the skier shall be allowed time to recover until next round of competition of that event has started or it can be satisfied, where possible on medical advice, that he is sufficiently recovered to continue. In the meantime, the competition goes on with succeeding skiers.

CHAPTER 13: VIDEO AND RADIOS

1301: ASSIGNMENT

The video camera shall be operated by a Video Operator or be affixed to a solid mounting device in the towboat.

1302: MEDIA

The Chief Judge is permitted to allow an additional accredited camera operator to ride in the towboat for the purposes of the media

1303: OFFICIAL USE

(A) When Permitted. The Event Judges are only permitted to view the official video of an event before the expiry of the protest time at the request of the Chief Judge or Chief Scorer, under the following circumstances:

- (1) Simple Majority.** To obtain a majority decision as to the skier's performance.
- (2) Failure of Timing Device.** To determine the time parameters of a pass in the event of failure of the timing device.

(3) Exceptional Circumstances. In circumstances which are judged to be exceptional, the Chief Judge or Chief Scorer is authorized to instruct the Event Judges to review the video recording to correct errors or misconceptions

(B) Jump Event. Event Judges are permitted to review the official video immediately so as to ascertain the validity of the jump before the next jump is taken.

See Part IV: Explanatory Notes for specific video review procedures.

1304: COMMUNICATIONS

Efficient two-way radios shall be provided for the Chief Judge, Assistant Chief Judge, Chief Scorer, Safety Director, Tournament Director, towboat, and jump computer station.

Wake Crest (Lift-Off Point) - Curled Shoulder 102

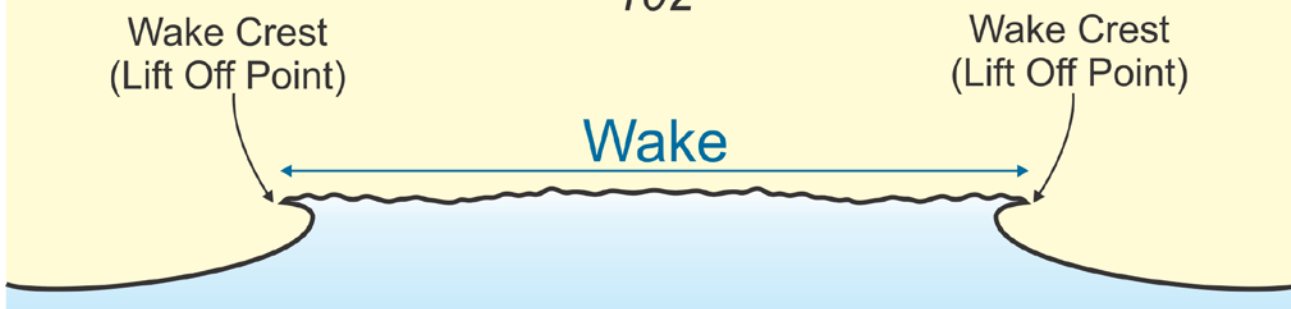

The wave curl is the point of the wave crest (lift-off point).

Wake Crest (Lift-Off Point) - Smooth Shoulder 102

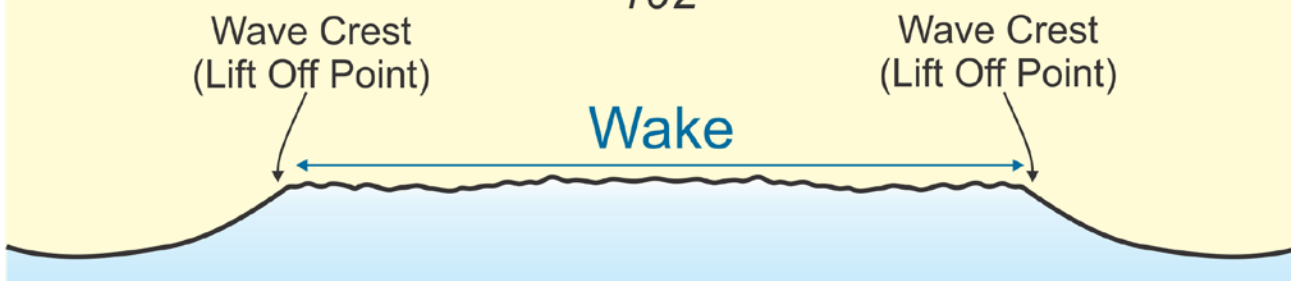

The point where the wave shoulder begins the downturn to the outside of the wake.

Slalom Points - Two-Foot Crossing 504(D)(1)

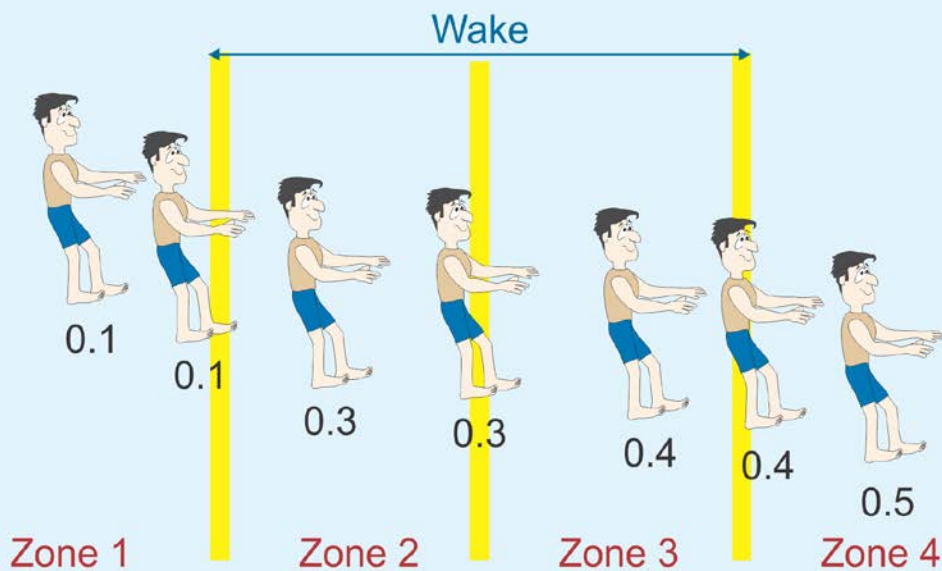

Slalom Points - One-Foot Crossing 504(D)(2)

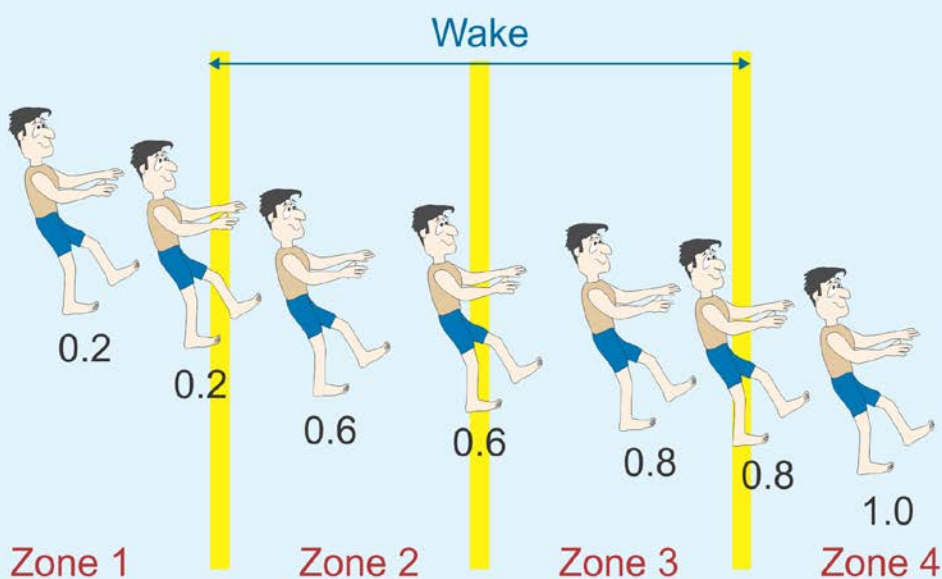

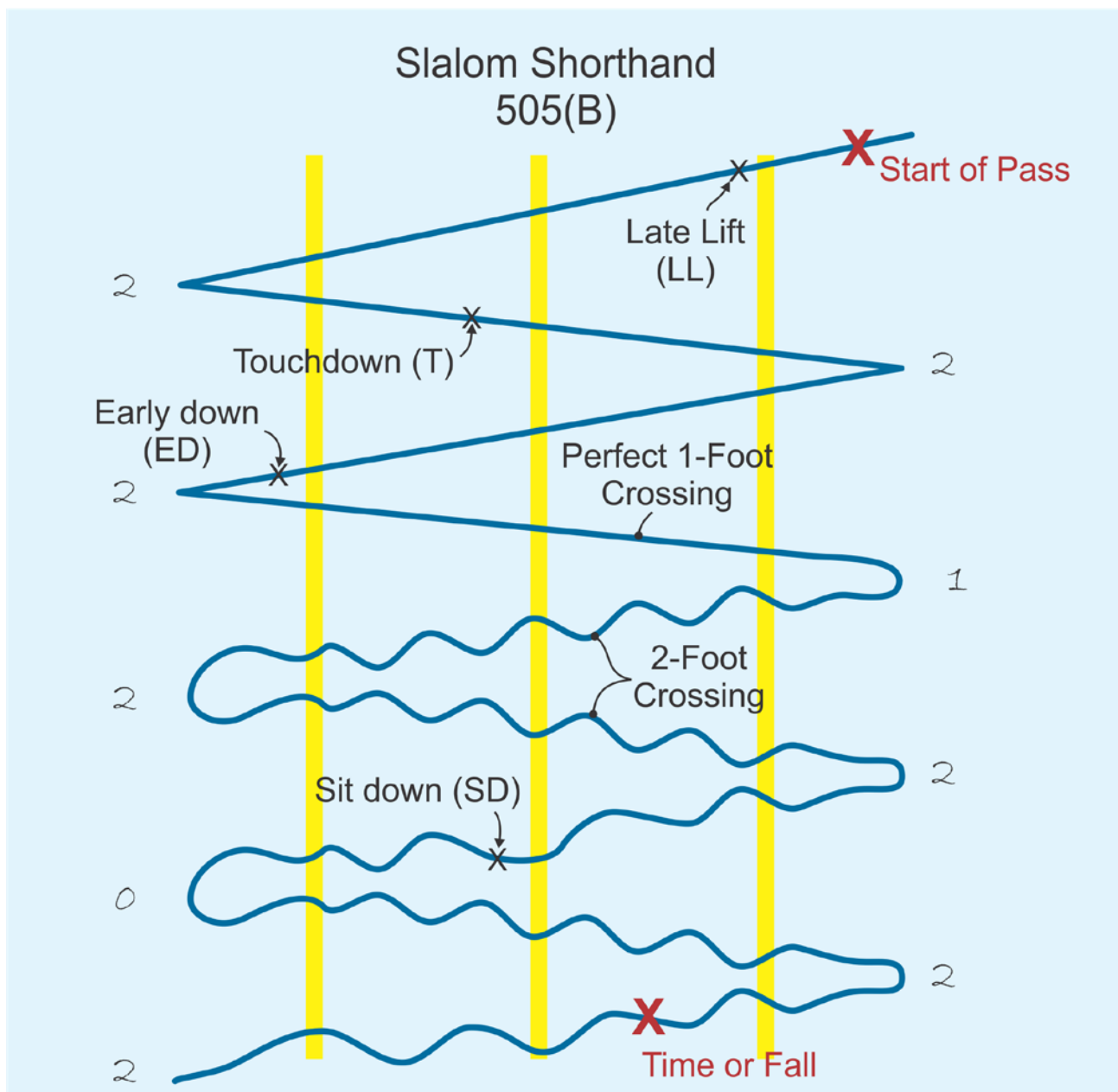

Start Points - 602				
	Two Feet	One Foot	Flyer Bonus	Tower Bonus
Front Deep	50	100	50	100
Front Toe-Up		400	50	150
Front Tumble	100	150	50	100
Back Deep	200	500	100	200
Back Toe-Up		450	50	200
Back Tumble	400	700	100	200
Back Line	400		100	250

	Trick Point Values - 712(A)				
	Surface Tricks		Wake Tricks		Wake-to Wake
	Two Foot	One Foot	Two Foot	One Foot	
General					
Hop Backward	100*		150§		250§
Hop Forward	20*		30§		100§
Knee Skiing	30				
One Foot Backward		100*			
One Foot Forward		30			
One Hand One Foot Backward		150			
One Hand One Foot Forward		50			
Rope in Teeth	20	50			
Rope on Neck	20	50			
Side Slide - Backward	450§				
Side Slide - Forward	200§				
Side Slide Switch	600§				
Sit Down/Stand Up	20	40			
Toe Sit Down/Starn Up		200			
Somersault (Flip)	700		850		1200
Toe Hold Backward		200			
Toe Hold Forward		100			
Tumble 180	50	100			
Tumble 360	50	100			
Wave	10				
Turns - Surface					
180 Back-to-Front	200	500	450	800	800
180 Front-to-Back	250	400	700	800	900
360 Back-to-Back	500	1000	1200	1600	1400
360 Front-to-Front	500	1000	1200	1600	1400
540 Back-to-Front	800	1500			
540 Front-to-Back	800	1500			
720 Back-to-Back	1000	1900			
720 Front-to-Front	1000	1900			
Turns - Step-Over					
Step-Over 180 Back-to-Front	450		700		
Step-Over 180 Front-to-Back	600				
Step-Over 360 Back-to-Back	1100				
Step-Over 360 Front-to-Front	1100				
Step-Over 540 Back-to-Front	1700				
Step-Over 540 Front-to-Back	1700				
Step-Over 720 Back-to-Back	2200				
Step-Over 720 Front-to-Front	2200				
Turns - Rope-on-Foot					
Toe Back-to-Front		900		1700	
Toe Back-to-Front Toe Start Recovery		300			
Toe Front-to-Back		400		800	

***Bonus Trick - 713(A)**
 Front Hop 1-foot 50
 Back Hop 1-foot 100
 Back Hop 2' Line 100
 Back Hop 1' Line 200
 Line 1-foot 100
 § One only i.e. no reverse

Start Points - 602

	Two Feet	One Foot	Flyer Bonus	Tower Bonus
Front Deep	50	100	50	100
Front Toe-Up		400	50	150
Front Tumble	100	150	50	100
Back Deep	200	500	100	200
Back Toe-Up		450	50	200
Back Tumble	400	700	100	200
Back Line	400		100	250

Tricks Shorthand Table - 714(B)

	Surface Tricks				Wake Tricks				Wake-to-Wake
	Two Foot		One Foot		Two Foot		One Foot		
	Basic	Rev	Basic	Rev	Basic	Rev	Basic	Rev	
General									
Hop	Λ		Λ>	<Λ	Λ _v				Λ _w
Knee Skiing	K								
One Foot			>	<					
Rope in Teeth	T		T>	<T					
Rope on Neck	N		N>	<N					
Side Slide-Backward	BSS								
Side Slide-Forward	SS								
Side Slide Switch	SSS								
Sit Down Stand Up	SD		SD>	<SD					
Toe Sit Down Stand Up			CD	DC					
Somersault (Flip)	O				O _v				O _w
Toe Hold			C.	.C					
Tumble 180	↵	↶	↵>	<↶					
Tumble 360	↷	↸	↷>	<↸					
Wave	W.	.W	W>	<W					
Turns									
180° Turn	1.	.1	1>	<1	1 _v	v1	1> _v	v<1	1 _w
360° Turn	3.	.3	3>	<3	3 _v	v3	3> _v	v<3	3 _w
360° OH Turn	⌢.	⌢							
540° Turn	5.	.5	5>	<5					
720° Turn	7.	.7	7>	<7					
Step Turn 180°	S1	1S			S _v	vS			
Step Turn 360°	S3	3S							
Step Turn 540°	S5	5S							
Step Turn 720°	S7	7S							
Toe Back-to-Front Ft-to-Ft			C ₁	1C			C _v	vC	
Toe Back-Front Toe Start Rec			C ₂	2C					
Toe Front-to-Back Ft-to-Ft			C ₁	1C			C _v	vC	

Part II:

HOMOLOGATION REQUIREMENTS

CHAPTER 14: Handles, Ropes, Timers, and Jump Ramp	45
CHAPTER 15: Towboats	48
CHAPTER 16: Course Requirements	49
CHAPTER 17: World Records.....	51
PART II: Graphics	54

CHAPTER 14: HANDLES, ROPES, TIMERS, AND JUMP RAMP

1401: GENERAL

There shall be sufficient quantities of tournament-supplied homologated ropes, handles, and timers on-site prior to the start of the tournament so as to ensure for the smooth operation of the tournament.

1402: HANDLES

Tournament-supplied handles shall meet the following requirements:

- (A) **Flotation.** Handles shall float or incorporate flotation.
- (B) **Grip.** The handle grip shall be made of 25mm to 28mm outside diameter material with no sharp edges or projections, and with non-slip coating. Attaching ropes shall in all cases go through the handle grip and shall be attached so there is no possibility of movement between the rope and handle grip when in use.
- (C) **Loop.** Handle bridles shall be finished with minimum 15cm loop.
- (D) **Length.** The handle and bridle shall have a length of 1.50m \pm 10cm
- (E) **Width.**
 - (1) **Jump Event.** A handle having a width of 30cm \pm 2.5cm, with a 30cm \pm 2.5cm length of attached ropes before juncture shall be the only handle used in the Jump Event.

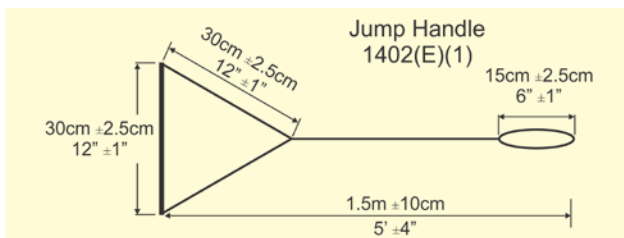

- (2) **Slalom and Trick Event.** A handle having a width of 38cm \pm 2.5cm, with a 38cm \pm 2.5cm length of attached ropes before juncture and a handle having a width of 30cm \pm 2.5cm, with a 30cm \pm 2.5cm length of attached ropes before juncture shall be the only handles used in the slalom event and shall be provided as tournament supplied handles for the slalom and trick event.

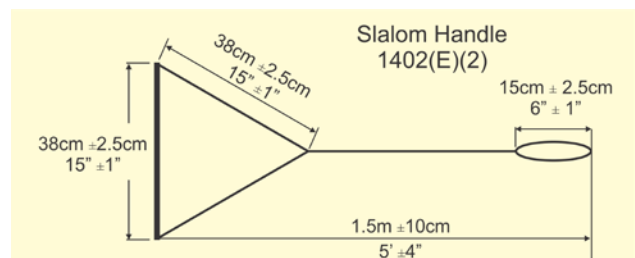

1403: ROPES

For the purposes of this rule a rope and leader combination shall be considered the "rope." The Tournament Committee shall have at least one rope meeting the following requirements in the towboat for all events:

- (A) **Stretch.** Ropes shall be made from a low-stretch plastic or similar material and have been sufficiently pre-stretched so as to allow only minimal stretch.
- (B) **Length.**
 - (1) **Rope.** The overall length of the tournament-supplied rope shall be 21.5m \pm 15cm.
 - (2) **Leader.** When the optional high attachment point is provided a leader of 2m \pm 15cm shall be attached to the middle attachment point [1501(D)(2)] and optional high attachment point [1501(D)(3)] and both shall be equipped with a lightweight fitting [1403(D)] for the attachment of ropes during the trick and slalom events.
 - (3) **Rope and Handle.** The tournament-supplied rope length with the handle shall be 23m \pm 25cm.

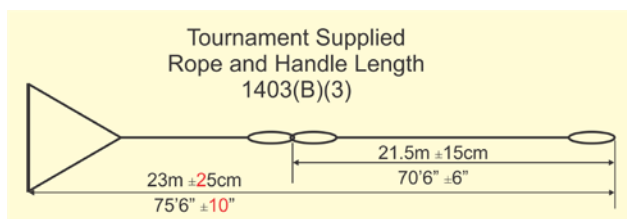

- (C) **Loops.** Loops shall be a minimum 15cm at the attachment end of the rope and a minimum of 40cm at the handle end of the rope.
- (D) **Rope Fittings.**
- (1) For easy attachment of ropes to leaders, a lightweight fitting shall be used during the slalom and trick events. A non-metallic fitting approved by the Chief Judge may be used in the jump event.
 - (2) Metal clips shall not be used in the jump event.
- (E) **Junctures.** Junctures in lines shall be by splicing or threading of adequate length to prevent slippage, and reinforced where necessary by knotting, stitching or binding.
- (F) **Measurement.** Measurements of ropes and handles shall be made with 20 kg (44 lb) of tension and shall be between the center of the handle grip (or inside of rope loop) and the inside of the rope loop at the other end.

1404: SKIER SUPPLIED ROPE AND HANDLE

- (A) **Rope and Handle.** For the Trick Event, the skier is permitted to furnish his own rope and handle of any size, length and material.
- (B) **Rope.** Loops shall be a minimum 15cm at the attachment end of the rope. Tying the rope to the attachment point is not permitted.
- (C) **Handle.** Detachable handles shall be finished with a loop approximately 40cm in length or lightweight fitting for easy attachment of handle.

1405: AUDIBLE TIMING DEVICE

In the Slalom and Trick Events, an automatic timing device giving an audible sound at the start and finish of timing the 15-second pass. Operation shall be by one of the following means:

- (A) **Majority Timer.** A timing device that provides three operating switches, one for each of the three Event Judges, shall operate as follows:
- (1) **Each Judge.** Each Event Judge shall operate his switch when he observes the start of pass as defined in 502 for Slalom and 702 for Tricks.
 - (2) **Two of Three Event Judges.** The timing device shall be programmed to sound the signal and start the 15-second timing at the moment when two of the three Event Judges have operated their starting switches. Thus, the first switch to be pressed in chronological order shall arm the device and thereafter the second to be pressed will activate it.
- (B) **Instantaneous Timer.** A timing device with a single operating switch shall be permitted. One of the Event Judges shall be assigned to operate the timer switch when he observes the start of pass.

1406: JUMP RAMP

The jump ramp shall meet the following specifications:

- (A) **Height.** The height of the lip of the jump ramp shall be 45.5cm ± 1.0cm above the waterline, measured on both sides.

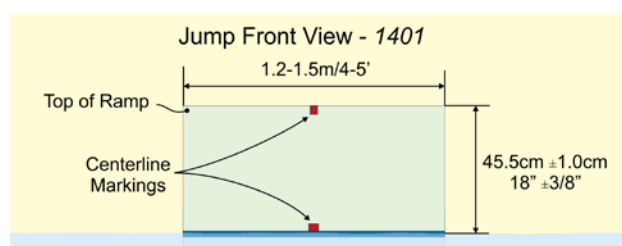

- (B) **Surface.** The surface of the ramp out of the water shall be $210\text{cm} \pm 4.2\text{cm}$ long, with the waterline marked by the center of a transverse line of contrasting color of a width equal to the total 8.4cm . The width of the ramp surface shall be a minimum of 1.20m and a maximum of 1.50m with parallel sides. The surface of the jump ramp shall be flat with a maximum deviation of $\pm 1\text{cm}$ from a plane. The overall length of the ramp surface shall be a minimum of 3.6m .

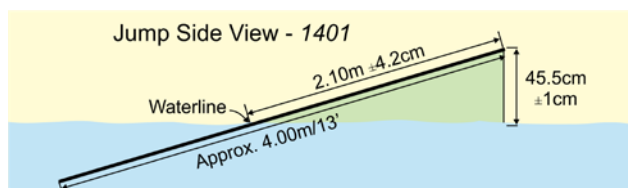

- (C) **Transverse Line Marking.** The centerline of the transverse line shall be marked at least at the edges of the ramp.
- (D) **Contrasting Color.** The submerged surface shall be of a dark color so as not to be visible to the skier. The exposed part above the waterline shall be of a light color.
- (E) **Strength and Stiffness.** The jump-ramp surface shall be the equivalent of 19mm marine plywood in strength and stiffness, suitably braced and with smooth integral or glued safe surfacing.

- (F) **Buoyancy.** Suitable buoyancy properly placed shall be used to ensure stability.

- (G) **Center Lines.** Centerline markings of a strongly contrasting color shall be placed at:

- (1) The front face of the ramp at the lip of the ramp to facilitate surveying.
- (2) The front face of the ramp at the waterline to facilitate measuring to the inner and outer course buoys.

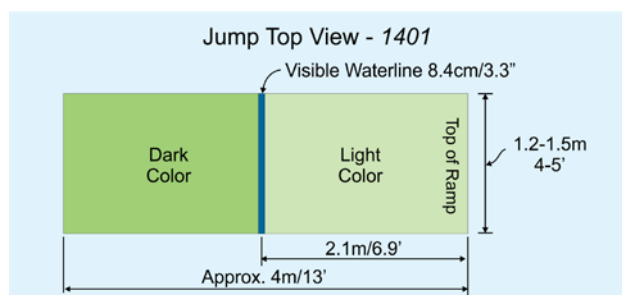

CHAPTER 15: TOWBOATS

1501: TOWBOAT SPECIFICATIONS

(A) Speed Guarantee. Towboats shall have the performance necessary to obtain 72 kph/44.7 mph while carrying the required boat officials and towing a barefoot skier weighing approximately 80kg/175lbs. by the entry gate for the Jump Event and skier's advisory buoy for the Trick and Slalom Event.

(1) Lengthen Course Run-Up. If necessary, the length of the run-up shall be adjusted, subject to the limits contained in 1602(A), to make the attainment of the required speed by the skier's advisory buoy possible.

(2) Full Throttle Acceptable. In complying with this speed requirement, it's understood that full throttle may be used throughout the acceleration phase.

(B) Engine Trim Position. Where engine-trimming capability is fitted to the towboat, the Homologator shall set the trim to achieve the required speed and optimum wake. This position shall be the default position for the tournament. Other than 303(H), it is the responsibility of the Driver to ensure the engine is at the default position before every skier.

(C) Size. Overall length shall be approximately 5m but shall not exceed 7m and the beam shall be not less than 1.80m and not more than 2.50m.

(D) Points of Attachment. Towboats shall be equipped with towing attachment points on the centerline of the towboat with the following heights above the water when the towboat is standing still with no occupants on board.

(1) Mandatory Lower Attachment Point.

1m +/- 25 cm.

(2) Mandatory Middle Attachment Point.

2m +/- 50 cm.

(3) Optional High Attachment Point.

4m +/- 50 cm.

(E) Speed-Measuring Devices. Towboats shall contain three speed-measuring devices:

(1) At least one speed measuring device shall be a GPS.

(2) Two shall be visible to the Driver.

(3) One shall be visible to at least one Event Judge when facing aft.

(F) Tachometers. Towboats shall be equipped with one tachometer.

1502: TOP SPEED

Before the start of the tournament the Chief Driver shall inform the Chief Judge of the maximum top speed as well as the top speed attained at the skier's advisory buoy for all towboats as per the conditions in 1501A and 1501B. This information shall be supplied to the competitors or team representatives before the start of the tournament.

1503: SPEED CHECK

(A) Boat Speed Check. Before each event and/or at the discretion of the Chief Judge, the towboat speed-measuring device shall be checked with a GPS speed-measurement device to obtain the correct boat speed under tournament conditions.

(B) Current or Stream. If there is a current or stream, the speed of that current must be added to the speed displayed in the GPS when traveling with the current and subtracted from the speed displayed by the GPS when traveling against the current.

1504: SPEED CONTROL

Speed control systems approved by the Homologator shall be used at the discretion of the Chief Judge.

CHAPTER 16: COURSE REQUIREMENTS

1601: JUMP COURSE

The Jump course dimensions shall be in accordance with the following:

- (A) **Jump Ramp.** The jump ramp shall be set parallel to the jump course. The method of determining this requirement can be either via a surveyed course or a measured course.
- (B) **Buoys.** No buoys or markers other than those required by 1602(A) are permitted within the jump course area except to mark safety hazards. Any such buoys shall be distinguishable from course buoys and shall be pointed out to team representatives/skiers before the start of the competition.
- (C) **Departure Point.** The departure point for the Jump Event shall be not less than 200m before the jump course entrance gate and shall be as close as possible to an extension of the course line.

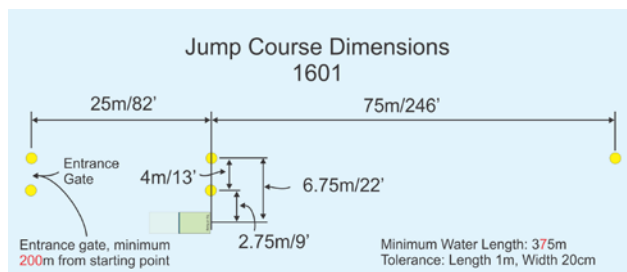

1602: SLALOM AND TRICK COURSE

- (A) **Course Dimensions.** The dimensions of the courses shall be as indicated in Figure 1602; however, the layout of the competition area may be varied to suit the tournament site. The competition site shall encompass a starting dock, skier advisory buoys, shutdown buoys and a turnaround buoy at the far end.

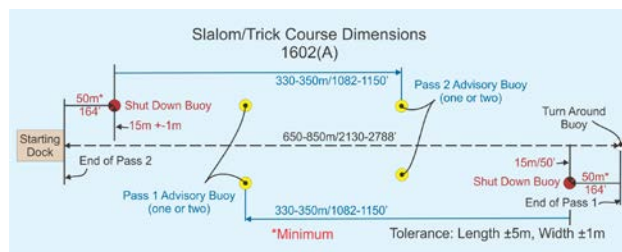

- (1) **Dock.** The starting dock shall be as near the extension of the course line as possible and shall be of a size to allow the skier to take more than one hop, skip or step on the dock before a dock start.
- (2) **Optional Tower.**
 - (a) Provision of a starting tower is optional at LOC discretion, and where provided it shall be between 2.5m and 5m above the water surface.
 - (b) The optional starting tower shall be as near the extension of the course line as possible and shall be of a size to allow the skier to take more than one hop, skip or step on the tower before a tower start.
- (3) **Course Line.** The course lines for the two passes should coincide if possible. If necessary for spectator viewing, the courses may be angled to or distanced from each other.
- (4) **Turnaround Buoy.** The distance between the starting dock and the turnaround buoy shall be not less than 650m and not more than 850m. The turnaround buoy shall be on the extended course line.
- (5) **Skier Advisory Buoys.** For both passes, a skier's advisory buoy(s) shall be located between 330m and 350m from the shutdown buoy, at a minimum of 15m from and perpendicular to the course line.

- (6) **Shutdown Buoy.** The shutdown buoy shall be located on the Driver's side approximately 15m from the course line a minimum of 50m from the turnaround buoy and shall be of a contrasting color to the skier advisory buoys.
- (a) The shutdown buoy marks the point at which the Driver shall smoothly close the throttle in order to safely stop the towboat before the end of the course.
- (B) **Buoys.** No buoys or markers other than those required are permitted within the competition area, except to mark safety hazards, landing or starting areas, or turning buoys. Any such buoys shall be distinguishable from course buoys and shall be pointed out to team representatives/skiers before the start of the competition.

CHAPTER 17: WORLD RECORDS

1701: RECOGNITION

The WBC shall recognize world records for jump distance, slalom crossings, and tricks points for all divisions. The Confederations are permitted to recognize records for divisions other than those recognized by the WBC. The nationality of the skier rather than the location of the tournament shall determine the Confederation and Federation in which a record is recognized.

1702: TOURNAMENT

(A) Where Set. World Records shall be set only at tournaments homologated by the WBC, a Confederation, or an Affiliated Federation.

(B) Record Capable Rounds.

- (1) No more than three rounds are permitted in any one competition, except that four rounds are eligible in a head-to-head competition.
- (2) World Record eligible rounds shall be declared before the start of the competition.

1703: JUMP

If the longest official distance credited in the Jump Event of a RC tournament exceeds the official record by 10cm or more, it shall be considered for a new World Record.

1704: SLALOM AND TRICKS

If the highest score in the Slalom or Tricks Event of a RC tournament exceeds the official record, it shall be considered for a new World Record.

1705: EQUAL PERFORMANCE

If a World Record score is equaled at a RC tournament, it shall be considered for co-holding the World Record.

1706: AFFIDAVIT—CLAIM DOCUMENTATION

(A) Homologator. Specifications of equipment, courses, and measuring devices shall be as specified in the WBC Technical Rule book and on the Official World Record Forms, which shall be completed and certified by the Homologator and all other required officials.

(B) Review in Descending Order. All performances in all record eligible rounds equal to or exceeding the existing record shall be put forward and reviewed in descending order until the best that can be verified is established.

(C) Qualified Review. The most qualified officials available shall review the claim and all details as per 1706(D) and 1706(E) while at the tournament. Whenever possible, the Confederational Record Review Committee Member should be included in the review of the claim before submission to the RRC Chairman. If this reviewing panel is satisfied that it's valid and the paperwork is in order, the claim shall be put forward as per 1706(F).

(D) Slalom and Trick Records. For Slalom and Trick records, the original Boat Judges scoring sheets and an electronic copy of the recording of the passes constituting the record taken from the towboat shall accompany the record application.

(E) Jump Record. A Jump record application shall include the electronic set-up file and two images: one image of the landing box and one of the jump landing. To ensure that the skier does not obscure the landing box buoys that are necessary for record review, an image of the landing box with no skier using the same camera set-up as the record claim image is necessary.

(F) Submission Deadline. The Homologator shall send a completed record application form, all electronic media, score sheets, and a copy of the homologation dossier to each member of the WBC Record Review Committee within fourteen days of the completion of an event.

- (G) **Contact Us.** Refer to www.WorldBarefootCouncil.com for application and contact details.
- (H) **Confirm Receipt of Application.** The Chairperson of the WBC Records Review Committee (RRC) is to confirm receipt of the record application via E-mail to the submitting Federation within one week of receipt.
- (D) **Jump.** The cursor position for a jump landing shall be approved by at least a two-thirds majority of the WBC.

1707: VERIFICATION

- (A) **RRC Membership.** The RRC shall consist of one representative from each Confederation. The RRC shall adjudicate all World Records.
- (B) **Decision Within 30 Days.** Within 30 days of the receipt of records, documents, and media, the RRC shall assess and promulgate the outcome of the record application.
- (C) **Federation Notified.** The Chairperson of the RRC is to advise the Federation and applicant on the outcome of the record application via E-mail.
- (D) **Slow Motion and Frame/Frame Review.** The RRC is free to use slow motion or frame-by-frame to review a record application.

1708: RECORD APPEALS

- (A) **Review by Entire WBC.** If a member of the RRC is aggrieved by a decision made by that Committee, they have the right to appeal the decision to the WBC. A review process by the entire WBC is then initiated.
- (B) **Review at Next Regular Meeting.** The WBC will itself scrutinize any appealed record application no later than its next meeting.
- (C) **Slalom and Trick.**
- (1) **Item by Item.** The video for a record shall be viewed trick-by-trick or crossing-by-crossing and shall be judged item by item. Each item shall be approved by at least a two-thirds majority of the WBC.
 - (2) **Approved as a Whole.** When all items of a slalom crossing or trick are approved, it shall be considered approved as a whole.

1709: RATIFICATION

All WBC Members shall be notified via E-mail of the new record and of the date of ratification as per 1707(B).

1710: RECORDS SET AT WORLD CHAMPIONSHIP

- (A) **Immediate Notification.** Scoring Programs shall be programmed to highlight any score that exceeds an existing World Record. The Scorers shall immediately forward this information to the Chief Judge, the Homologator, and the Chief Video Officer.
- (B) **Before the End of Championship.** Whenever possible, the RRC shall adjudicate all World Records set at World Championships before the end of the Championships.
- (C) **Substitute RRC Member.** The RRC shall scrutinize, approve or reject all World Records set at the Championships. If any member of the permanent RRC is not in attendance at the Championships or is unable to fulfill the commitment for any other reason, the WBC Chairman shall appoint a substitute committee member from among the Level 1 Judges in attendance. This substitute should be a WBC Member whenever possible.
- (D) **Appeal.** If any RRC member is aggrieved by a decision made by the RRC, the WBC shall scrutinize and approve or deny the pending record at the World Championships.
- (E) **Homologator Responsibilities.** The Homologator shall consult with the RRC Chairman and the Chief Judge immediately upon notification of a pending record to facilitate the preparation of all documentation to enable the immediate review of any pending World Records. The Homologator tasks include:
- (1) Sourcing the original Judge's sheets.
 - (2) Sourcing a copy of the video recording of the pending record.

- (3) Coordinate a panel of Judges and immediately review the pending record.
 - (4) Prepare the required paperwork for presentation to the RRC Chairman after the review panel approves the pending record.
- (F) Documents to Skier or Team Representative.** The Chief Judge of the World Championships shall provide the Skier or Team Representative all evidence and documentation necessary for substantiating any pending Federation or Confederation record set at the World Championships.
- (G) Others Afforded Access for Record Verification.** The Team Representative and any of his Confederation Council or WBC Members shall also be afforded the facilities to scrutinize the pending Confederation or Federation record or make record verification.

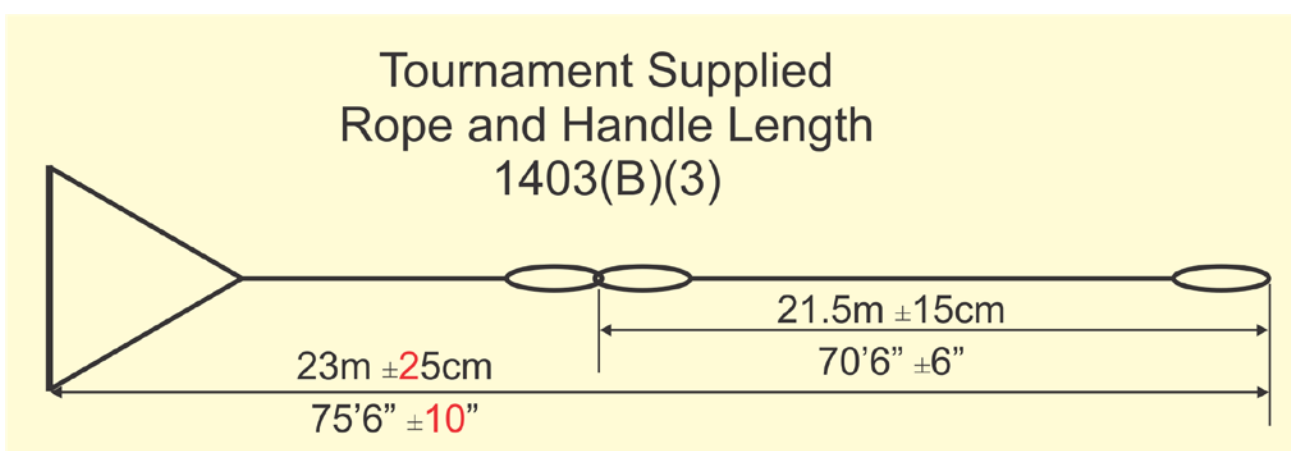
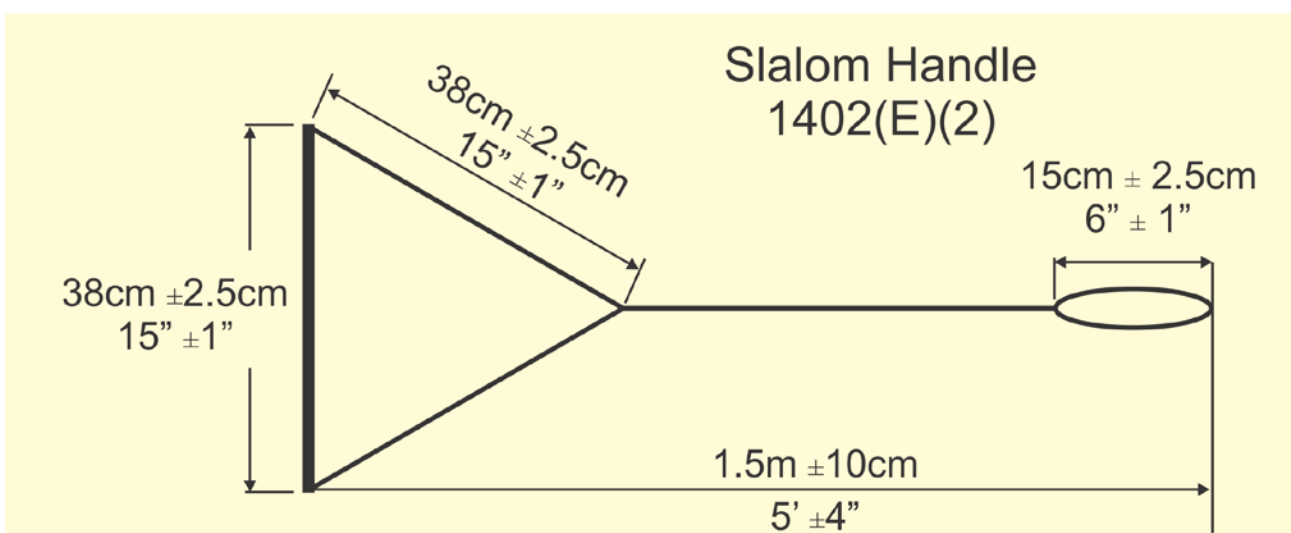
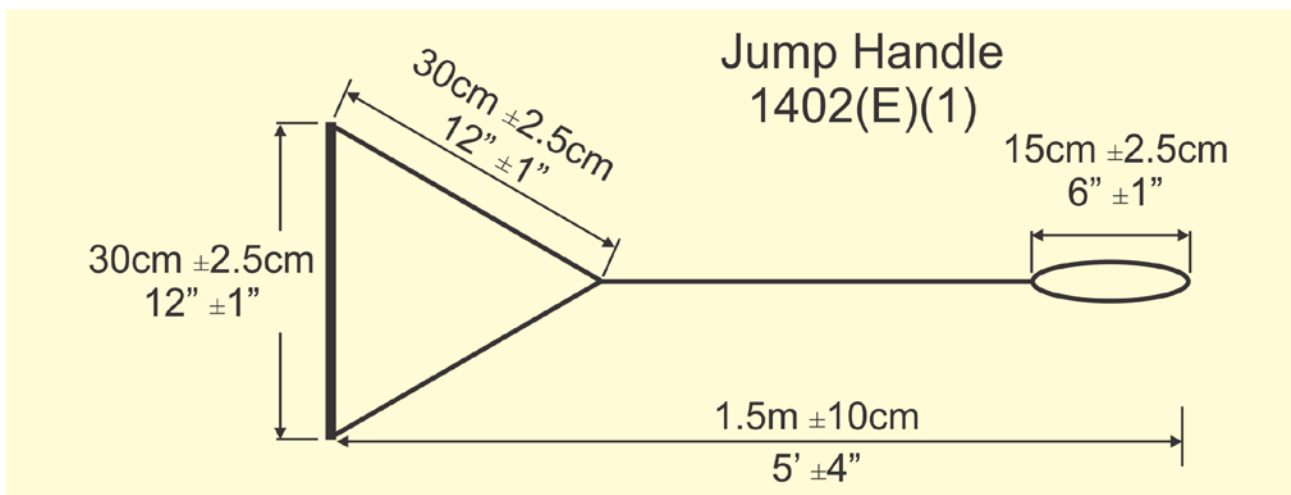

Jump Front View - 1401

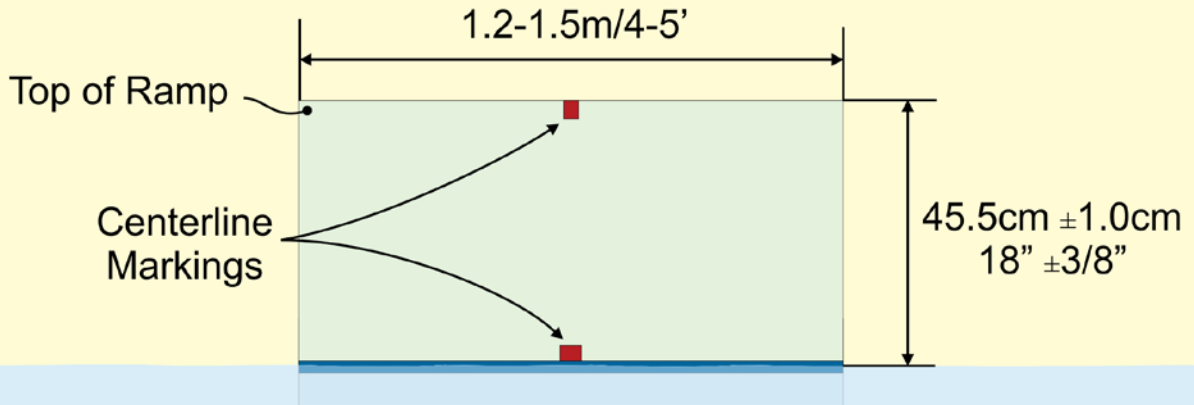

Jump Top View - 1401

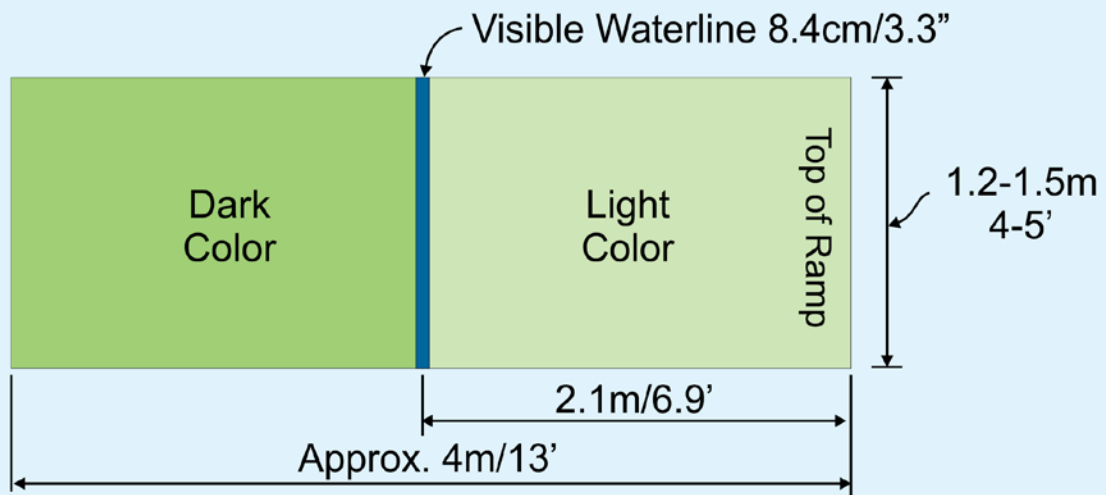

Jump Side View - 1401

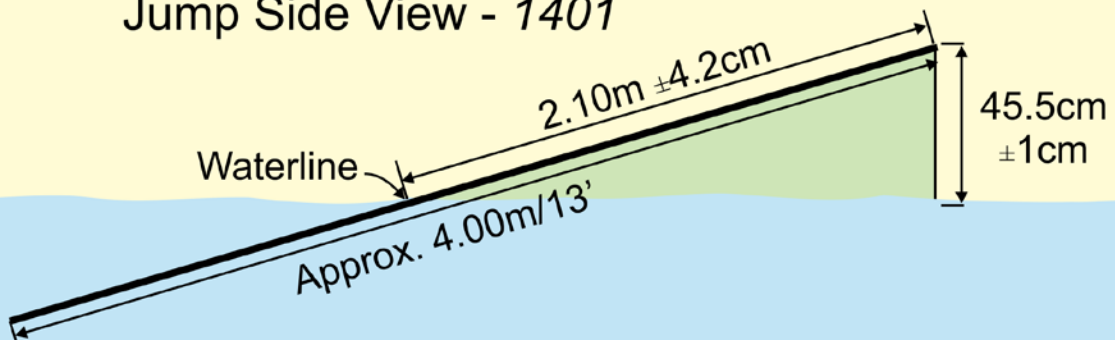

Part III:

WORLD CHAMPIONSHIPS REQUIREMENTS

CHAPTER 18: General Requirements World Championship	58
CHAPTER 19: Divisions, Events, and Rounds of Competition— World Championship	60
CHAPTER 20: Entry Requirements—World Championship	63
CHAPTER 21: Overall and Team Ranking—World Championship	66
CHAPTER 22: Officials—World Championship	69
CHAPTER 23: Video—World Championship	71

CHAPTER 18: GENERAL REQUIREMENTS

WORLD CHAMPIONSHIP

1801: SCHEDULING

Through calendar year 2021, the Barefoot Waterski Championships shall be held biennially and shall be comprised of three Championships with the Open, Junior and IWWF World Masters Championship (“Masters Worlds”) being held concurrently. Thereafter, beginning calendar year 2021, the Open and Junior World Barefoot Waterski Championships shall be concurrently held biennially in even-numbered years, and the Masters Worlds shall be held biennially in odd-numbered years.

1802: SITE CLOSURE AND SET UP

Unless the Chairman of the WBC and the LOC have agreed to previous homologation arrangements, the tournament site shall be declared closed at midday on the day prior to the start of the championship. At that time the towboats, courses and all associated equipment shall be available for homologation.

1803: ON-SITE MEDICAL FACILITIES

The Safety Director shall appoint a Tournament Medical Officer to provide the following services wherever possible:

- (A) **Medical Officer.** A suitably qualified Medical Officer shall be in attendance during all tournament events.
- (B) **Medical Station.** A suitably equipped medical station prepared to deal with a medical emergency will be conveniently located at the tournament site.
- (C) **Transportation.** Suitable transportation to safely and promptly move an injured skier to a local medical unit for additional medical care.
- (D) **Prompt and Qualified Treatment.** A working relationship will be established between the local hospital or medical unit and the Tournament Medical Officer, such that casualties will get prompt and qualified treatment when required.

1804: TOWBOATS

- (A) **Approval.** The towboats to be used in the World Championships shall be approved by the WBC. Inboard, inboard-outboard or outboard power can be used. This information shall be provided to the Chairman of the Barefoot Council of each Confederation not less than six months before the tournament.
- (B) **Event Boat Selection.** The towboats to be used for each event shall be decided by the LOC. If more than one type of towboat will be used, the information in 1804(A) shall include a list of the events scheduled for each towboat.
- (C) **Identical Boats.** Identical towboats shall be used for all contestants in a division for each event.

1805: ROPES AND HANDLES

- (A) **Notification.** Information of the type of rope and handles shall be provided to the WBC not less than 6 months before the tournament. If more than 1 type of rope and handle will be used, this information shall include a list of the events scheduled for each type of rope and handle.

1806: SAFETY DIRECTOR

- (A) **Appointment.** At least 2 months before the tournament, the Tournament Committee shall appoint a Safety Director who will appoint such assistants as he deems necessary.

1807: DRIVER FAMILIARIZATION

Prior to the start of the tournament the Boat Drivers shall familiarize themselves with the tournament towboats, courses, rates of acceleration, top speed, underwater obstructions, etc. The Chief Driver shall administer this familiarization and ensure all drivers provide uniform rates of acceleration and lines through the courses

1808: COMPLETION

Once a World Championship has started the Chief Judge does not have the authority to cancel any event and the tournament shall be completed, even if obliged to continue in another community, unless the WBC decides otherwise on the recommendation of the Chief Judge.

1809: VALIDITY

The inability of a country to attend the World Barefoot Waterski Championships for any reason does not require that the Championships be cancelled or postponed or that the Championships are any the less World Championships.

CHAPTER 19: DIVISIONS, EVENTS, AND ROUNDS OF COMPETITION—WORLD CHAMPIONSHIP

1901: DIVISIONS OF COMPETITION

(A) **Divisions.** Competition in each event shall be separated into **girls and women for female skiers and boys and men for male skiers** in accordance with 2002.

(1) **Junior Division (Girls/Boys).** The competitors shall be under 17 years of age at midnight on December 31st of the year proceeding the Championships year. Entries of teams and independents shall be accompanied by proof of age.

(2) **Dual Entry.** Skiers that fulfill the requirements of 2003 are permitted to be entered by their Federation in both the Open and the Junior World Championships.

(3) **Masters Championships.** Competitors (women/men) shall be 35 years of age or older at midnight on December 31st of the year proceeding the Championships year. Entries shall be accompanied by proof of age. The Masters Championships shall be held separately pursuant to Rule 1801 and shall be governed by the IWWF World Barefoot Masters Championships Rules ("Masters" Rules), which are attached as Appendix A. In the event of conflict, the Masters Rules shall take precedence over these Rules.

1902: EVENTS

The events are Jump, Slalom and Tricks for all divisions.

1903: CHAMPION AND EVENT PLACEMENTS

A champion and succeeding places shall be determined for each event and for the Overall in each division, and for the Federation Teams as described in Chapter 21.

1904: NUMBER OF EVENT ROUNDS

(A) **Three Rounds.** For Open/Junior Divisions each event shall consist of 3 rounds; the first round, second round and third/final round

(B) **Eight or Fewer Skiers.** If there are 8 or fewer skiers then a maximum of 5 top scores shall advance to the second round.

(C) **Tie Breaking.** A runoff to break a tie shall never be considered a round of competition and scores obtained from tie runoffs shall only be used for the purpose of breaking a tie. Runoff scores are not valid for overall scores, WBC Ranking List or a record.

1905: SCHEDULE OF EVENTS

(A) **Setting up and Announcement of the Schedule.**

(1) **Proposed Schedule.** Not later than 8 weeks before the start of the tournament, the Tournament Director shall send a proposed schedule of events to the Chairman of the WBC. Upon approval by the WBC, the Tournament Director shall disseminate the approved schedule to each affiliated Federation.

(2) **Starting Times.** 2 days prior to the start of the tournament, the Tournament Director and the Chief Judge shall set starting times for each day.

(3) **Guidance Only.** A schedule of starting times for individual events shall be for the guidance of the skiers, and any deviation shall not constitute a change in schedule.

(B) **Schedule Changes.**

(1) **Necessary Changes.** The Chief Judge may make changes in the schedule that are necessary to the expeditious and safe operation of the tournament.

(2) **Media Coverage.** Taking account of the importance of media, the Chief Judge is also authorized to make changes designed to increase or improve the coverage.

- (3) **Skier Notification.** All affected skiers shall be notified by posting on the official notice board and by announcement over official PA system.
- (4) **Change Discourage.** Although changes are to be discouraged, the Chief Judge shall not hesitate to make changes dictated by safety.

1906: SITE FAMILIARIZATION

- (A) **Team Skiers.** The LOC is required to ensure that, if requested, each team be allocated, free of charge, an elapsed period between leaving and returning to the dock equal to 8 minutes multiplied by the number of skiers in the team. The division of this time among the team members is the responsibility of the team representative. This time may be incorporated into pre-event training if the boats, ropes, handles, jump ramp and all courses are as they will be for the Championships.
- (B) **Independent Skiers.**
 - (1) An independent skier entered in the trick and/or slalom event shall be given free of charge familiarization time of two passes for each event in which he is entered,
 - (2) An independent skier entered in the jump event shall be allowed free of charge familiarization time of one jump,
 - (3) An independent skier that is qualified in more than one event may use his familiarization passes for any event he is entered.
 - (4) Familiarization for independents shall be scheduled as close to their Federation's team scheduled familiarization time as practical. The LOC shall schedule independents with no Federation team present wherever expedient.
- (C) **Starting Order.** The starting order in familiarization shall, as far as practicable, be in the order of distance traveled from home base, e.g., the further the travel the later the turn.

See Part IV: Explanatory Notes for specific site familiarization procedures.

1907: SEEDING SCORES

- (A) **Seeding Scores.** The WBC rankings database shall be used to generate each skier's seed score as follows:
 - (1) Based on a period starting on January 1 of the year prior to the year of the upcoming applicable world championships and concluding 4 weeks before the official start date.
 - (2) Skiers with no score on the rankings database as per 1907 (A)(1) shall be grouped with the lowest seed group after all skiers with RL scores.

1908: STARTING ORDER

- (A) **First Round Starting Order.** Before the start of the tournament the entry list shall be closed and thereafter the entries shall be divided into a Male and a Female seeding list for each Championship.
- (B) **Groups.** Based solely on those seeding lists all skiers shall be divided into groups between 8 to 16 skiers and those respective orders shall be posted as soon as possible.
- (C) **Numbers.** The numbers of skiers per group shall be at the discretion of the Chief Judge.
- (D) **Reverse Order.** The skier starting order for each group shall be in the reverse order of their seeding scores.
- (E) **No Protest.** Incorrect grouping or seeding shall never be grounds for a re-ride or protest.
- (F) **Dual Entries.** All dual division skiers shall ski a first round in each Championship entered.
- (G) **Final.** In the final round of an event, the starting order of the finalists shall be in the reverse order from their qualifying scores and shall be grouped by divisions.
- (H) **No First Round Contested.** If 1904(C) is applied the starting order shall be in reverse order of the seeding scores.
- (I) **Change of Order.** Only the Chief Judge may change the skier starting order, except that a team representative may:

- (1) Withdraw a skier from the competition.
 - (2) Replace, with the authority of the Chief Judge, an injured skier with a qualified reserve from the same team as per 2002(D).
- (J) **Ties.** Any ties in starting order placement shall be broken by the flip of a coin.
- (K) **Positive Score.** To be eligible for the final round a skier shall have a positive score in the first round of that event.

1909: SECOND ROUND

- (A) **Number of Skiers.** No distinction shall be made between team and independent skiers when deciding who goes into the second round. The total number of skiers in the first round determines the number of skiers qualifying to go into the second round as follows:
- (1) **8 or fewer.** If there are 8 or fewer skiers, all skiers will advance to the second round without contesting the first round.
 - (2) **9 to 12 skiers.** If there are 9 to 12 skiers, 8 skiers will advance to the second round
 - (3) **13 to 16 Skiers.** If there are 13 to 16 skiers, 9 skiers will advance to the second round.
 - (4) **17 or 18 Skiers.** If there are 17 or 18 skiers, 10 skiers will advance to the second round.
 - (5) **19 or 20 Skiers.** If there are 19 or 20 skiers, 11 skiers will advance to the second round.
 - (6) **More than 20 Skiers.** If there are more than 20 skiers, 12 skiers will advance to the second round.

1910: THIRD/FINAL ROUND

- (A) **Who Qualifies.** The third/final round of any Open Division event shall always comprise five skiers, unless fewer make a positive score in the second round or a qualified skier is unable to compete due to illness, injury or other reason.
- (1) **First Three Skiers.** The first three skiers, based on the results of the second round, shall be qualified to ski in the third round of that event. When the top three skiers from the second have been selected, all their scores shall be removed from a copy of the combined results list of the first two rounds of the event.
 - (2) **Next Two Skiers.** The skiers having the two top remaining scores on the combined event results list shall go into the third round.

Note: A skier is not required to ski in the second round to be eligible to ski in the third round.

1911: LAST QUALIFIER TIE BREAKING

- (A) **Ties.** Ties for last qualifying place for the Final round of the Open Division shall be broken as follows:
- (1) **Jump.** Each tied skier shall be allowed three jumps to break the tie. This runoff shall proceed until the tie has been broken.
 - (2) **Slalom.** Each tied skier shall be allowed two passes to break the tie and this runoff shall proceed until the tie has been broken.
 - (3) **Tricks.** Each tied skier shall be allowed two passes to break the tie and this runoff shall proceed until the tie has been broken.
- (B) **Running Order for Tied Skiers.** The running order for all ties shall be determined by the flip of a coin.

CHAPTER 20: ENTRY REQUIREMENTS— WORLD CHAMPIONSHIP

2001: NATIONALITY

Each Federation shall certify to the WBC that all team and independent skiers meet the qualifications set out in the IWWF Rules of Eligibility. These rules can be found at: worldbarefootcouncil.com.

2002: TEAM COMPOSITION

(A) Junior Championships (Boys/Girls). Each Federation affiliated to the IWWF shall have the right to select a team comprised of four members with a maximum of three of any one sex, to represent it in the Junior World Barefoot Championships.

(B) Open Championships (Men/Women). Each Federation affiliated to the IWWF shall have the right to select a team comprised of six members with a maximum of five of any one sex, to represent it in the Open World Barefoot Championships.

(C) Reserve Skiers. Each Federation shall furthermore have the right to nominate two reserve skiers to each team. Prior to the start of the tournament and at the discretion of the Team Representative, reserve skiers may be substituted in for any reason. After the start of the tournament skiers shall only be replaced by reserves due to injury. The injured skier shall not compete in the tournament after replacement is made.

- (1) A reserve skier shall take part only in those events of which the first round has not yet started at the time the replacement is made.
- (2) The reserve skiers, if not called upon shall have the right to ski as independents if so qualified.
- (3) Reserve skiers replacing skiers of the opposite sex shall not participate in any event in which the first round for the skier they are replacing has started at the time the replacement is made, e.g. a male reserve who is replacing a female skier shall not ski in a male jump if the female jump first round has already started.

(4) Any scores posted by a reserve skier while skiing as an independent shall never count toward Team Overall calculations.

(D) Team Representative. Each team shall select a representative whose name shall be given to the Chief Judge at least 72 hours before the start of the tournament.

(E) Independent Representative. Federations shall select a representative whose name shall be given to the Chief Judge at least 72 hours before the start of the tournament.

2003: INDEPENDENT ENTRANTS

(A) Qualification Scores. Skiers not selected for their National teams may qualify to compete in the World Championships as independents by achieving a qualifying score.

Qualifying scores for all divisions and events shall be determined in the following way:

- (1) Less than 16 RL Skiers.** The qualify score shall be based on the 8th RL rated skier.
- (2) 17 or 18 RL Skiers.** The qualify score shall be based on the 9th RL rated skier.
- (3) 19 or 20 RL Skiers.** The qualify score shall be based on the 10th RL rated skier.
- (4) 21 or 22 RL Skiers.** The qualify score shall be based on the 11th RL rated skier.
- (5) 23 or 24 RL Skiers.** The qualify score shall be based on the 12th RL rated skier.
- (6) 25 or 26 RL Skiers.** The qualify score shall be based on the 13th RL rated skier.
- (7) 27 or 28 RL Skiers.** The qualify score shall be based on the 14th RL rated skier.
- (8) 29 or 30 RL Skiers.** The qualify score shall be based on the 15th RL rated skier.
- (9) 31 or 32 RL Skiers.** The qualify score shall be based on the 16th RL rated skier.
- (10) 33 or 34 RL Skiers.** The qualify score shall be based on the 17th RL rated skier.

- (11) **35 or 36 RL Skiers.** The qualify score shall be based on the 18th RL rated skier.
- (12) **37 or 38 RL Skiers.** The qualify score shall be based on the 19th RL rated skier.
- (13) **39 or More 40 RL Skiers.** The qualify score shall be based on the 20th RL rated skier.

Note: The Nth RL rated skier is found by counting that number of skiers down from the first skier on the list. I.E. If there are tied skiers they still take up one place each on the list.

The Minimum Standard for Independent Skier qualification for Jump in all divisions shall be 8 meters regardless of the number of skiers on the RL or the lowest score on the RL for that division.

*The qualifying period shall start **January 1 of the even year** of the most recent World Championships and shall conclude 4 weeks prior to the upcoming World Championships. **Note the Rule only applies to Open and Juniors.***

- (B) **Previous World Champions and Record Holders.** All previous World Overall and World Event Champions, and all current World Record Holders, are eligible for entry to the World Barefoot Championships with the endorsement of their Federation without regard to 2003(A). Event Champions and record holders can only enter those events in which they are previous World Champions or current record holders. Previous Overall champions may enter any or all events. This rule does not qualify Junior or Senior Champions to compete in the Open Championships. This rule does not qualify Junior Champions to compete in the Junior Championships unless they meet the age requirements as set out in 2002(A).
- (C) **Federation Entry.** Their Federation shall enter all skiers qualified as independents.
- (D) **Overall Points.** Skiers entered as independents shall be awarded overall points for the events in which they qualify.
- (E) **Team Overall.** Independent skier's overall scores shall not affect team overall scores.

2004: JUMP PROFICIENCY

- (A) **Ranking List.** Skiers entering the Jump Event must have achieved one of the following proficiencies:
- (1) A positive jump score on the current RL
 - (2) A positive jump score in a RL tournament up to four weeks prior to the World Championships.
- (B) **Non-Ranking List.** The Chairman of that Confederation shall certify skiers entered in the jump event from countries that have not held RL tournaments during the qualifying period.

Note: No skier will be allowed to jump if, in the opinion of the Chief Judge, Safety Director and a simple majority of the Event Judges, his competing would be a danger to himself [210(B)].

2005: ENTRY REGISTRATION

- (A) **Intent to Compete.**
- (1) **Eight Weeks.** Not later than eight weeks before the scheduled start of the tournament, each Federation intending to field a team and/or Independents in the World Barefoot Waterski Championships shall certify to the Chairman of the WBC and to the LOC its intent to compete and their estimated entries on the Intent to Enter Form.
- Note: See PPG for the Intent to Enter form.*
- (2) **Late Fee.** Any Federation not meeting this requirement shall not be allowed to compete until they pay a fine of \$200 (USD) to the WBC.
- (B) **Definitive Entry.**
- (1) **Team Skiers.** Not later than 4 weeks before the scheduled start of the Championship, each Federation intending to enter a team shall certify to the Chairman of the WBC, the Chairman of the Confederation Barefoot Council the Chief Judge and the LOC, the names of the skiers (Maximum of six for Open, four for Junior, and four for Senior) that will be skiing team members, and the events each will enter on the Definitive Entry Form. The names of up to two reserves for each team shall also be submitted on the same form.

- (2) **Final List.** Not later than 72 hours before the start of competition a Final Team List must be submitted in writing to the Chairman of the WBC and the Chief Judge. This list, which shall be comprised solely of skiers named on the Definitive Entry Form, shall clearly indicate which are Team Skiers and which are Reserve Skiers as well as their relevant divisions. Failure to do so will disqualify the team from the team event
- (3) **Independent Skiers.** Not later than 4 weeks before the scheduled start of the tournament, each Federation shall submit the names of any of its qualified independent skiers it wishes to enter, and the event or events they will enter on the Definitive Entry Form.
- (4) **Late Fee.** Any Federation not meeting these requirements will not be allowed to compete until the Federation pays to the WBC a fine of \$20 (USD) per skier per day after the four-week deadline, for each skier not officially entered.
- (C) **Deadline.** The Local Organizing Committee for the Masters World shall announce deadlines for registration, similar to those described in Rule 2005 (A) and (B), above.
- (D) **Event Management System (EMS).** To the extent a tournament registration is conducted under the Event Management System (EMS), the EMS system controls all aspects of registration. Federations must ensure that their skiers and tournaments are registered and recorded on the EMA system in order for their skiers to be eligible for World Championships.

Note: See PPG for Definitive Entry Form.

CHAPTER 21: OVERALL AND TEAM RANKING— WORLD CHAMPIONSHIP

2101: EVENT PLACING

- (A) **Placement.** Event placing shall be based on the final round, followed by the previous rounds results. Any skier that contests the final round shall always place higher than the skiers who did not.
- (B) **Medal Round.** If no final round can be held due to force majeure, then the final medal placement of skiers shall be determined by using the best score registered by each skier in the most recently completed round of the event.

2102: CHAMPIONS

All divisions shall have champions in Jump, Slalom and Tricks, and an Overall Champion. There will be no event champion in events in which there are fewer than three competitors.

2103: TIES

- (A) **Gold Medal Tie.** If there is a tie for the gold medal in any event the following rules shall apply:

- (1) **Jump.** A runoff of three jumps per skier between the tied skiers shall be used to break the tie. This runoff shall proceed until the tie has been broken. The order of skiing shall be determined by the flip of a coin. The skier posting the highest score in the runoff shall be declared the event champion, and the skier posting the lower score shall be the silver medalist.
- (2) **Slalom.** A runoff of two passes per skier between the tied skiers shall be used to break the tie. This runoff shall proceed until the tie has been broken. The order of skiing shall be determined by the flip of a coin. The skier posting the highest score in the runoff shall be declared the event champion, and the skier posting the lower score shall be the silver medalist.

- (3) **Tricks.** A runoff of two passes per skier between the tied skiers shall be used to break the tie. This runoff shall proceed until the tie has been broken. The order of skiing shall be determined by the flip of a coin. The skier posting the highest score in the runoff shall be declared the event champion, and the skier posting the lower score shall be the silver medalist.

(4) Run-off Not Possible.

- (a) **Jump.** Should a runoff not be possible due to weather, force majeure, or injury through no fault or action of the skier, then the longest jump attained by a tied skier from any round of the competition shall be declared the event champion and the other tied skier shall be declared the silver medalist. Should the skiers still be tied, then the second longest jump attained by a tied skier from any round of the competition shall be declared the event champion and the other tied skier shall be declared the silver medalist.
- (b) **Slalom or Tricks.** Should a runoff not be possible due to weather, force majeure, or injury through no fault or action of the skier, then the highest score attained by a tied skier from any round of the competition shall be declared the event champion and the other tied skier shall be declared the silver medalist. Should the skiers still be tied, then the second highest score attained by a tied skier from any round of the competition shall be declared the event champion and the other tied skier shall be declared the silver medalist.

- (B) **Silver Medal Tie.** In the event of a tie for the silver medal, all tied skiers shall be awarded a medal and there shall be no bronze medal award.

- (C) **Bronze Medal Tie.** In the event of a tie for the bronze medal, all tied skiers shall be awarded a medal.

2104: OVERALL SCORING—APPLICATION

(A) Team Overall Points. Team overalls are based on scores made by team skiers in any completed first or second round of an event.

- (1) Team Overall points are used to calculate the team results only.
- (2) Team Overall points are definitive for team results.

Note: Team scoring requirements are contained in 2108.

(B) Individual Overall. Individual Overalls are based on scores made by all skiers in any completed round of an event and are used to calculate the individual event overall rankings.

- (1) Individual overall points are used for all divisions, and thus determine the Individual Overall Champions and succeeding places.

2105: OVERALL SCORING—CALCULATION

(A) Team Overall Points. The best score by any team skier in any completed first or second round of an event shall, be awarded 1000 Team Final Overall points and shall be used to calculate the Team Overall points for all team skiers.

(B) Team Skier Overall Points. All other performances by team skiers in those rounds shall be calculated according to the following formula, where the term 'top performance' refers to the best score by a team skier in any completed first or second round.

Team Skier's Overall =
Team skier's best score x 1000/top performance

(C) Rounding. Event and Overall scores shall be rounded to two decimal places.

(D) Individual. The best score by any skier in any completed round of an event shall be awarded 1000 Individual Overall points and shall be used to calculate the Individual Overall points for all skiers.

(E) Individual Overall Points. All other performances by skiers in any completed round shall be calculated according to the following formula, where the term 'top performance' refers to the best score by any skier in any round of the event.

Individual Overall Points =
Skier's best score x 1000/top performance

(F) Dual Division Overall Points. For dual division skiers the score for their single first round will be recorded for the first round of both divisions. The score for subsequent rounds shall only be used for the division in which it was scored.

2106: QUALIFICATION FOR OVERALLS

To be considered for overall placing, a skier shall post a positive score in at least one event.

2107: OVERALL PLACING

Places in the Individual Overall Championship shall be determined by totaling each skier's overall points as determined in 2105.

2108: TEAM PLACING

(A) Open Team

- (1) In Open Team scoring the best three overall scores per team, men and/or women, in each event, as detailed in 2105(B), shall be totaled to obtain the team score.
- (2) The three skiers whose results are used for a team score may differ from event to event.
- (3) The skiers whose scores are used in team scoring shall be identified on the team results.

(B) Junior Team.

- (1) In Junior Team scoring, the best two overall scores per team, boy and/or girl, in each event, as detailed in 2105(B) shall be summed to obtain the team score.
- (2) The two skiers whose results are used for a team score may differ from event to event.
- (3) The skiers whose scores are used in team scoring shall be identified on the team results.

2109: SCORE SHEETS ACCESS

- (A) **Team Representative.** For the first 10 minutes after event results posting, team representatives may only view the scoring sheet(s) of their own skiers.
- (B) **All Skiers.** Eleven minutes after result posting, team representatives shall have access to the score sheet(s) of any competitor in that event.
- (C) **Skier Access.** After event results have been posted, skiers shall have access to their own scoring sheets under the direct supervision of the team representative or a person appointed by the Chief Judge.
- (D) **Viewing Area.** Score sheets shall not be removed from the designated viewing area.

CHAPTER 22: OFFICIALS—WORLD CHAMPIONSHIP

2201: CHIEF OFFICIALS

- (A) **Nomination Deadline.** No later than eleven months prior to the World Championships, Confederations or WBC members shall submit nominations in the form of a resume to the Secretary of the WBC for the positions of Chief Judge, Assistant Chief Judge, Chief Scorer, Assistant Chief Scorer, Chief Driver, Chief Video Operator, Homologator and Tournament Director.
- (B) **WBC Approval Deadline.** No later than ten months before the World Championships, the WBC shall make their recommendation for appointments by simple majority vote. The Chairman of the WBC shall then submit the recommended nominations to the Chairman of the IWWF.
- (C) **Appointment by IWWF Deadline.** No later than nine months before the World Championships, and on the recommendation of the WBC, the Chairman of the IWWF shall appoint the above-mentioned positions for the World Championships.
- (D) **Different Confederations.** The Chief Judge, Assistant Chief Judge and Chief Scorer shall be from different Confederations whenever possible.

2202: APPOINTED JUDGES, SCORERS AND DRIVERS

- (A) **Nominations.** No less than 10 months prior to the championship or before a date to be announced by the WBC, Confederations or WBC members shall submit nominations to World Championships. These nominations shall be submitted in the form of a resume.
- (B) **Approved by WBC.** No less than 9 months prior to the Championships or before a date to be announced by the WBC, the Appointed Judges, Scorers and Drivers shall be decided by a simple majority vote of the WBC from those resumes submitted.
- (C) **Notification of Appointment.** The IWWF Chairman shall inform the Confederation Chairmen and the Appointed Officials of these appointments via E-mail within one week of the decision.
- (D) **Qualifications.** The Nominated Judges, Scorers and Drivers shall be Level 1.
- (E) **Quantities of Appointed Officials.**
 - (1) **Single Lake Sites.** On single lake sites, in addition to the Lead Officials, there shall be 9 Appointed Judges, 2 Appointed Drivers and 1 Appointed Scorer.
 - (2) **Two Lake Sites.** For two lake sites, additional officials shall come from each of the three confederations. The numbers of officials shall be based on the site and other considerations determined by the CJ, LOC and WBC Chairman. The Chief Judge shall appoint one of the Appointed Judges as Assistant Chief Judge of the second lake.
- (F) **Reserve.** Each Confederation may provide a Reserve Judge, Scorer and Driver for replacement(s) as deemed necessary by the Chief Judge. Whenever possible the Reserve, if used, shall come from the Confederation where the vacancy is.
- (G) **Insufficient Quantity.** If there are not enough qualified officials available from any Confederation, the Chairman of the WBC shall select additional officials from other Confederations.
- (H) **Supervision.** The Chief Judge shall select Event Judges and Assistants for each event and shall supervise all judging and scoring operations. The Chief Judge and the Assistant Chief Judge shall not serve in the towboat.
- (I) **Exclusion.** Officials appointed by the WBC, including the Safety Director plus any other appointed personnel who have access to official video footage of the Championships, shall not be permitted to ski in the World Championships

2203: SECONDARY POSITIONS

- (A) **Secondary Positions.** Personnel to fill secondary positions shall be selected by the Chief Judge from other experienced Judges and officials in attendance.
- (B) **Announcer.** Announcers are appointed by the LOC and are to serve under the authority of the Chief Judge.
- (C) **Secretary.** A Chief Judge's Secretary shall be appointed by the Organizers to provide administration support to the Chief Judge. The Secretary shall be computer literate, have high levels of administration skills and good local knowledge of the LOC's personnel and facilities.
- (D) **Pickup Drivers.** Pickup drivers shall be provided by LOC and shall be trained in water rescue techniques. Whenever possible, the Chief Judge shall assign an appointed official to be the pickup driver so they can monitor changing water conditions throughout events.
- (E) **Dock Official.** Dock officials shall be provided by LOC and assigned by the Chief Judge. Whenever possible, the Chief Judge shall assign an appointed official to the starting dock to monitor the conditions and observe boat paths.

2204: INDEPENDENCE

Where possible, Event Judges shall be separated to ensure completely independent opinions. Until the expiry of the protest period the Event Judges shall not confer on their score except to determine the last trick in time [714(D)] or to provide provisional results when an optional re-ride is offered in accordance with 1003.

2205: REPLACING OFFICIALS

The Chief Judge is permitted to replace Event Judges and Drivers during an event at his discretion. Such changeover shall take place between groups.

2206: AFFIDAVIT

The Chief Judge and each Appointed Official shall sign a statement on the prescribed form at the conclusion of the Championships that the rules were followed implicitly, noting any exceptions allowed.

CHAPTER 23: VIDEO—WORLD CHAMPIONSHIP

2301: APPOINTMENTS

- (A) **Video Operators.** The host Federation of a World Championship shall appoint a minimum of three suitably experienced Video Operators who shall be responsible to the Chief Video Operator. Six operators shall be appointed on two lake sites.
- (B) **Video Camera.** A video camera shall be used to make a permanent record of all events.
- (C) **Ownership.** The WBC shall own the official video recordings of the championships. Any reproduction or broadcasting requires the approval of the WBC.

2302: AVAILABILITY

- (A) **Official Assistance.** The video recording forms the official assistance to the Chief Judge, the Event Judges, and the WBC.
- (B) **Available to IWWF.** For this purpose, the original or a good copy shall be made available, free of charge, on-site to the IWWF for internal use and marketing.

2303: BOAT LOADING

- (A) **Ballast Added.** Should a camera operator leave the towboat during an event, sufficient ballast shall be placed in the towboat for the remainder of the event to avoid a significant change to the towboat wake.
- (B) **Ballast Removed.** Should a camera operator board the towboat during an event, sufficient ballast shall be removed from the towboat for the remainder of the event to avoid a significant change to the towboat wake.
- (C) **Two Camera Operators.** Two camera operators authorized in 1302 shall be allowed to ride in the towboat at the same time if the towboat wake is not adversely affected to a significant degree.

Part IV:

RULE CLARIFICATIONS

RULE 208: New Tricks	73
RULE 213(B): Minimum Requirements for Boat Officials	73
RULE 214: WBC Ranking List	73
RULE 407: Jump Measurement and Calculation	73
RULE 712: Credit for Pass Tricks	73
RULE 903: Chief Judge Decision	74
RULE 1303: Official Use	74
RULE 1303(A)(2): Failure of Timing Device	75
RULE 1303(A)(3): Exceptional Circumstances	75
RULE 1501: Boat Specifications	75
RULE 1706: Affidavit—Claim Documentation	76
RULE 1906: Site Familiarization	76
RULE 2204: Independence	77

CHAPTER 24: Rule Clarification

This Section provides additional explanations or clarification of the listed Technical Rules. The listed Rules as shown in italics are a direct extract from the Rule Book and are followed by explanatory notes. This context formerly resided in the Procedures, Policies and Guidelines on the WBC web site.

RULE 208: NEW TRICKS

To qualify new tricks for inclusion in the next World Championships, applications for those new tricks shall be submitted to any member of the WBC no less than 120 days before the next World Championships and the WBC shall then adjudicate on them no less than 60 days before the next World Championships. This application shall be in the form of a video recording of the perfect trick on the long line accompanied by a written description of the trick and proposed point value for consideration by the WBC.

Explanatory Notes: *Failure by the WBC to make a determination within the required time frame will result in the application automatically being rejected from inclusion in the upcoming World Championships.*

RULE 213(B): MINIMUM REQUIREMENTS FOR BOAT OFFICIALS

(3) World Barefoot Championships. There shall be three Level 1 Judges in the towboat. A single Level 1 Judge is permitted to replace the three Judges in the towboat in order to obtain and maintain a minimum of 72 kph/44.7mph through the course as required in 1501(A).

Explanatory Notes: *The “One-Judge” system should be employed at a World Championships, or Confederation Championship only when the minimum boat speed under Rule 1501 (A) cannot be achieved.*

RULE 214: WBC RANKING LIST

(C) Rounds.

- (1) No more than four rounds per day are permitted in any one competition.

- (2) Ranking list rounds shall be declared before the start of the competition.

Explanatory Notes: *This does not mean only four rounds are permitted in any competition but that only four rounds of RL are allowed per day. Tournaments may have unlimited numbers of rounds but the four rounds that will be eligible for RL score submission must be declared before the start of the event. For multi-day tournaments, 4four RL rounds are permitted and must be declared each day.*

RULE 407: JUMP MEASUREMENT AND CALCULATION

A WBC-approved video jump-measurement program shall be used to obtain jump distances. Such a system will not be subject to reading errors and shall produce results that are reproducible on readily available systems. The distance gleaned from the video will be final.

Note: Approved jump measurement programs are listed in the PPG or the WBC web site.

Explanatory Notes: *The following jump measurement systems have been approved by the WBC:*

- Corson Jump Measurement System
- Boetcher Jump Measurement System
- SplashEye Jump Measurement System

Additional approved jump measurement systems may be posted on the WBC web site from time to time.

RULE 712: CREDIT FOR PASS TRICKS

(B) Highest Scoring Sequence. The highest scoring sequence of turns that complies with all rotation Rules shall be used for scoring a trick run.

Explanatory Notes: *When scoring a trick run, the scorers must use the sequence of tricks that gives the skier the highest possible score within that sequence or group of tricks. Examples:*

- (1) A positional turn performed immediately prior to or following a four 180-degree surface turn sequence can be ignored, provided that the positional turn complies with the rotational Rules under 803(A)(1);
- (2) Should the last basic and first reverse turn in a sequence of 180-degree turns be judged as a 360-degree turn and the skier has also made another 360-degree turn that would be deemed a repeated trick the 360-degree turn within the two 180-degree turns, the turn shall be deemed to be two 180-degree turns.
- (4) Note that video review is often not necessary when one Judge requests video review. If the other two Judges have established a majority, then review is not necessary. It is not necessary for all three Judges to be simultaneously present for video review. One Judge may be able to review the video and make a determination to establish the necessary majority. Sometimes it may require two or all three Judges to establish a majority. Those whom are available should begin review to determine if a majority can be established.

RULE 903: CHIEF JUDGE DECISION

Chief Judge Authority. After the Chief Judge has been made aware of all the facts pertaining to a decision made by any official, the Chief Judge may then overrule that decision in order to ensure compliance with all rules.

Explanatory Notes: *The Chief Judge is not required to poll the officials to adjudicate protests or overrule any poor decisions. The Chief Judge may poll the officials if the Chief Judge wishes. The Chief Judge may review any relevant evidence to reach his/her decision. This rule applies not only to protests, but also to any decision made by any official that does not comply with the Rules.*

RULE 1303: OFFICIAL USE

(A) When Permitted. The Boat Judges are only permitted to view the official video of an event before the expiry of the protest time at the request of the Chief Judge or Chief Scorer, under the following circumstances:

- (1) **Simple Majority.** To obtain a simple majority decision as to the skier's performance.

Explanatory Notes:

- (1) Video review shall be done in silence, maintaining the independence of the Judges.
- (2) The Chief Judge or the Chief Scorer may request an Event Judge to review the video if it is not possible for the Scorers to obtain a majority decision as to the skier's performance.
- (3) Errors or misconceptions cannot be corrected during video review. The Judges may only make decisions on issues that have no established majority.
- (5) The Event Judges should notify the Scorers of any passes requiring video review when the score sheets and videotapes/diskettes are returned from the boat. The Chief Scorer should immediately provide this information to the Chief Video Officer for the queuing of the passes.
- (6) Video review shall always be viewed at normal speed. The video may be viewed as many times as necessary to allow the Judge(s) to make a decision.
- (7) Judges may not confer while reviewing the video.
- (8) When reviewing a trick pass where the Judge(s) are experiencing difficulty in determining the actual tricks performed in the pass, the Judge may choose to stop the video after a number of, or sequence of, tricks are executed. This is commonly known as "chunking." Chunking provides the opportunity for the Judges to focus on one or two tricks, rather than the complete trick pass. Once these tricks have been scored, the next trick or group of tricks where a majority decision cannot be reached are reviewed.
- (9) Any Judge who is still in doubt after viewing the video must refresh his/her knowledge of the applicable Rules and make his/her own determination without outside influence, other than advisement from the Chief Judge.
- (10) Clarifications of the applicable Rules are encouraged but the final decision rests with the Event Judge, unless the Chief Judge invokes Rule 903.

RULE 1303(A)(2): FAILURE OF TIMING DEVICE

This Rule clarifies how to determine the time parameters of a pass in the event of failure of the timing device.

Explanatory Notes:

- (1) If the start or end of pass cannot be determined by the combined use of the official video and the Judges' sheets, then a re-ride is mandatory. [1004(B)]
- (2) If expiry of time is the only issue that has no majority it is not necessary for the Event Judges to view the video. Any two officials appointed by the Chief Judge may determine the expiry of time and the last trick completed in time or the zone of the last crossing in slalom.
- (3) Should the two appointees not be able to establish an agreement, a third appointee shall be added to attempt to establish agreement.
- (4) Should the three appointees be unable to establish an agreement, the Chief Judge shall become the sole arbiter.
- (5) These appointees are only allowed to determine the expiry of time. They cannot determine whether a trick is for credit or a crossing was perfect or imperfect.

RULE 1303(A)(3): EXCEPTIONAL CIRCUMSTANCES

In circumstances which are judged to be exceptional, either the Chief Judge or Chief Scorer may instruct the Boat Judges to review the video recording to correct errors or misconceptions.

Explanatory Notes: "Exceptional circumstances" are not a defined set of events. The Chief Judge or Chief Scorer may determine what constitutes an exceptional circumstance. Examples:

- (1) Where a Judge clearly does not know the applicable Rules for a circumstance or has been judging under a misinterpretation of a Rule;
- (2) Where Event Judges' sheets are so varied that it is clear that something has broken down in the judging system in the boat;

- (3) Where two or more Event Judges have overlooked a circumstance or occurrence that changes the outcome of the event.
- (4) A protest can be regarded as exceptional circumstances.

RULE 1501: BOAT SPECIFICATIONS

- (C) Size.** Overall length shall be approximately 5m but shall not exceed 7m. The beam shall be not less than 1.80m and not more than 2.50m.

Explanatory Notes: The WBC approved towboat list below does not disqualify any boat that conforms to Rule 1501. This list is solely to allow ease of homologation. Where these boats are used in competition, there is no requirement to complete the homologation section relating to towboats other than to record the make and model of the towboat.

WBC Approved Towboat List

- "The Beast" ProStar 190 6.0L by MasterCraft (with barefoot plate)
- Barefoot Nautique (rear engine)
- Barefoot Nautique (mid-engine)
- Charger Ski Boats- Barefooter (4-stroke outboard)
- Custom Ski Boats Protege (outboard or inboard)
- Custom Ski Boats Probe (outboard or inboard)
- Extreme Comp Barefooter by Ski-Pro
- Gecko Inboard Barefooter
- Malibu FlightCraft Outboard
- Raven Barefooter (outboard)
- Response Barefooter by Malibu Boats
- Sanger Outboard Barefooter
- Sanger DXII Barefooter
- Ski Brendella Outboard
- Ski Centurion Outboard
- Any other boat listed as an approved towboat on the WBC web site.

RULE 1706: AFFIDAVIT—CLAIM DOCUMENTATION

- (C) **Qualified Review.** The most qualified officials available shall review the claim and all details as per Rules 1706(D) and 1706(E) while at the tournament. Whenever possible, the Confederation's Record Review Committee member should be included in the review of the claim before submission to the RRC Chairman. If this reviewing panel is satisfied that the claim is valid and the paperwork is in order, the claim shall be put forward as per Rule 1706(F).

Explanatory Notes: A Scrutiny Committee must review all potential records onsite before the record is forwarded to the WBC or Federation Records Committee. The Homologator or Chief Scorer shall advise the CVO of all potential records as soon as possible. Copies shall then be made of potential records from the event media for the sole purpose of record review. This process allows review and ratification of records to proceed without interfering with the ongoing tournament.

RULE 1906: SITE FAMILIARIZATION

- (A) **Team Skiers.** The LOC is required to ensure that, if requested, each team be allocated, free of charge, an elapsed period between leaving and returning to the dock equal to eight minutes multiplied by the number of skiers in the team. The division of this time among the team members is the responsibility of the team representative.

(B) **Independent Skiers.**

- (1) An independent skier entered in the trick and/or slalom event shall be given free of charge familiarization time of two passes for each event in which he is entered.
- (2) An independent skier entered in the jump event shall be allowed free of charge familiarization time of one jump.
- (3) An independent skier who is qualified in more than one event may use his familiarization passes for any event he is entered.
- (4) Familiarization for independent skiers shall be scheduled as close to their Federation's team scheduled familiarization time as practical. The LOC shall schedule independents with no Federation team present wherever expedient.

- (C) **Starting Order.** The starting order in familiarization shall, as far as practicable, be in the order of distance traveled from home base, i.e., the further the travel the later the turn.

Explanatory Notes:

Management of Site Familiarization

- (1) Site Familiarization shall be under the control of the Local Organizing Committee (LOC).
- (2) The LOC shall ensure the tournament competition area, jump course and ramp, start docks and towers is in tournament ready condition and the towboats and tow ropes used for site practice/site familiarization are identical to those that will be used in the tournament.
- (3) The contestants will be permitted to familiarize themselves with the tournament site, ramp, and equipment.
- (4) Site Familiarization shall be integrated into the time made available to all teams for paid practice during the week(s) preceding the start of the tournament.
- (5) The LOC shall advise Federations in Bulletin No. 2 of the cut-off date when teams and independent skiers are required to register for free of charge (FOC) site familiarization.
- (6) The LOC is required to ensure that if a Federation registers an intent to undertake site familiarization by the cut-off date, the team will be allocated an elapsed period between leaving and returning to the dock, equal to eight minutes FOC multiplied by the number of skiers in the team. The division of this time among the Team Members is the responsibility of the Team Representative.
- (7) An independent skier who registers an intent to undertake site familiarization by the cut-off date, shall be given three minutes FOC familiarization time for each event in which he is entered, up to a maximum of eight minutes. Familiarization for independents shall be scheduled as close to their Federation's team scheduled familiarization time as practical. The LOC shall schedule independents with no Federation team present wherever expedient.

- (8) Federations and Independent skiers who do not register for site familiarization with the LOC prior to the cut-off date shall be allowed FOC site familiarization time if and only as the established site familiarization schedule permits.
- (9) The starting order for Federations registered for FOC familiarization shall, as far as practicable, be in the order of distance traveled from home base, i.e., the further the travel the later the turn.

RULE 2204: INDEPENDENCE

Where possible, Event Judges shall be separated to ensure completely independent opinions. Until the expiry of the protest period the Event Judges shall not confer on their score except to determine the last trick in time [714(D)] or to provide provisional results when an optional re-ride is offered in accordance with Rule 1003.

Explanatory Notes: *Judges may not confer on the issues or express their opinions before, during, or after video review until the protest time has expired.*



INTERNATIONAL WATER SKI & WAKEBOARD FEDERATION



“World Masters Championships” Format **Prepared by Senior World Championships Committee**

February, 2018

Version 6

IWWF WORLD MASTERS CHAMPIONSHIPS

The technical rules shall be identical to those in the most current WBC Technical Rules with the exception of the modifications to the Technical Rules as stated below:

It is generally understood that any reference to the World Championships shall be applicable to this tournament if appropriate.

RULE 1—CHAMPIONSHIP EVENTS

1.01: Events

There shall be 3 events: Slalom, Tricks and Jump. Individual Overall scoring is from either round. Team scoring is from either round.

1.02: Rounds

All skiers will ski the first round in their divisions seeded in order of the rankings list from the previous 2 years.

All skiers will ski the second round in their divisions seeded in order of their first-round scores. Skiers with no first-round score do not ski in the second round.

The second round is considered to be the final round.

1.03: World Championships Entry and Administration

Deadlines shall be set by the organizer with approval of the Chairman of the IWWF Barefoot Council.

1.04: Approval of Entry by Federation

All skiers must be approved to enter by their federation.

RULE 2—CHAMPIONSHIP ENTRY REQUIREMENTS

2.01: Team Selection

All federation entries will make up the federation team.

2.02: Skier Eligibility

Skiers eligible for this competition are Men and Women in the age categories listed below.

All ages refer to the age of the skier on the 31st December of the previous year.

Division	Slalom	Tricks	Jump
a) 35-44	✓	✓	✓
b) 45-54	✓	✓	Separate medal event and not part of overall. Will be able to be calculated in the teams scores.
c) 55-64	✓	✓	
d) 65+	✓	✓	

Skiers must ski in their age division.

2.03: Minimum Number of Skiers in a Division

3 Skiers skiing in the event for the event to be run. If only 2 skiers or less enter, then they must enter a lower age group. If only 2 skiers or less enter in 35-44 then 45-54 will combine and jump will be added as an event and tricks and slalom will be the calculation method overall.

RULE 3—OVERALL AND TEAM SCORING AND COMPETITION

3.01: Overall Scores

Individual overall scores will be calculated by the skiers top score from the two rounds.

Division	Events Included in Overall
35-44	Tricks, Slalom, Jump
45-54	Tricks, Slalom
55-64	Tricks, Slalom
65+	Tricks, Slalom

Age divisions of 45 and over will have a combined jump event. The scores for this event will not be included in the individual overall scores.

3.02: Team Scoring

Only one score, being the federation's top score from each division from each event will be used to calculate the team's results. The score taken will be the thousandised overall score for the division.

This means that if a federation has 3 skiers in a division then only 1 score can be used per event, and a different skiers score per each event (tricks, slalom & jump 35-44) can be used to calculate the team result.

3.03: Team Scoring Single Score From All 8 Division

Division	Event	MALE	FEMALE
35-44	3		
45-54	2		
55-64	2		
65 and over	2		

RULE 4—JUDGES AND ASSISTANTS

4.01: Choosing Appointed Judges

There shall be at least one judge from the two confederations that the championships are not being held in.

4.02: Not Officiate

Judges, drivers, and scorers may not officiate in the age divisions in which they compete.

4.03: Lead Officials

The lead officials will be limited to:

- a) Chief Judge
- b) Assistant Chief Judge/Level 1 Judge
- c) Homologator/Level 1 Judge—non-skier
- d) Chief Scorer—non-skier
- e) Two Level 1 Judges—non-skiers
- f) Chief Driver/Driver—non-skiers
- g) Chief Video

4.04: LOC Must Provide

The LOC will provide the following for the officials listed in 4.03.

- a) Accommodation
- b) Meals each day of the competition, or a meal allowance
- c) Pick up from the airport

Daily transport will be coordinated by the officials and federation teams.

4.05: Balance of Officials

The balance of level 1 and 2 officials will be made up by skiers and members of the LOC, with two judges and one driver from each age division. These officials will not be provided with accommodation, meals or airport pick up.

Division	Judges/Scorers	Drivers
35-44 years	2	1
45-54 years	2	1
55 years and over	2	1
TOTAL	6	3

RULE 5—NAMES OF CHAMPIONSHIPS

Junior World Championships

Open World Championships

World Masters Championship 35-44

World Masters Championship 45-54

World Masters Championship 55-64

World Masters Championship 65 and over

RULE 6—X GAMES

5.01: When Held

Immediately following the conclusion of the Senior Championships an X-games event will be held.

5.02: Participants

Five open division skiers will participate in the event. The balance of the skiers will made up of Senior Division skiers. This format is still being defined in conjunction with the successful LOC.

RULE 7—SENIOR RECORDS

On the completion of the 2020 World Championships, records for seniors/masters will be listed per the age division in The Records History.